



Intelligent Transport Systems (ITS)

Introduction Guide

Intelligent Transport Systems (ITS)

Introduction Guide

PREFACE

Lately, a number of countries in Asia Pacific Region have been developing road infrastructure rapidly. Meanwhile, rapid economic growth and population concentration in urban areas have caused urban traffic problems such as congestion, accidents, and environmental problems that became serious in developing countries as well as in developed countries. In such circumstances, several countries are making attempt to resolve such traffic problems using Intelligent Transport Systems (ITS), some of them showing significant improvement. In order to introduce and advance ITS in countries, it is critical to share common perceptions of knowledge/expertise in the following aspects: 1) how to employ ITS effectively in order to resolve urban traffic issues, 2) how to integrate information technologies and transport infrastructure, and 3) how to build a platform for ITS to perform properly.

Given such environment, Asian Civil Engineering Coordinating Council (ACECC) approved the establishment of the Technical Committee for the theme of “ITS-based Solutions for Urban Traffic Problems in Asia Pacific Countries (TC-16),” proposed by the Japan Society of Civil Engineers (JSCE) at the Technical Committee Coordination Meeting in Tokyo, on March 1, 2012.

The TC-16 consists of ten members from eight countries: Japan, Korea, Thailand, Taiwan, Australia, Malaysia, the Philippines, and the United States. Since its establishment, we have collected examples of ITS-based solutions using state-of-the-art Information and Communication Technologies (ICT) for aforementioned common issues in Asian countries, and encouraged discussion on approaches of ITS introduction according to country’s level of economic growth and national land development.

In this Guide, we described ITS-based solutions for urban traffic problems and low-cost ITS introduction processes in detail, based on discussions in the TC-16 activities. In addition, examples of ITS introduction and its various applications in different countries are presented for reference.

Lastly, we strongly wish that civil and road engineers in Asian countries take advantage of this “ITS Guide” and the Guide will contribute to resolving transport issues. This publication is supported by International Scientific Exchange Fund (ISEF) of JSCE. And we would like to take this opportunity to express our sincere gratitude for those supported and advised in the course of development of the Guide.

Chief Editor Hiroshi MAKINO

August, 2016

ACECC TC16 TC MEMBERS

Chair	Hiroshi MAKINO (ITS Division, NILIM, MLIT, JAPAN)
Co-Chair	Shunsuke KAMIJO (Institute of Industrial Science, University of Tokyo, JAPAN) Chi-Hyun Shin (Kyonggi University, Korea)
Member	Sorawit Narupiti (Chulalongkorn University., Thailand) Jason Chang (National Taiwan University., Taiwan) Edward Chung (Queensland University. of Technology, Australia) Ahmad Farhan Mohd Sadullah (University. Sains Malaysia, Malaysia) Ching-Yao Chan (University of California at Berkeley, USA) Ricardo G.Sigua (University of the Philippines, the Philippines)
Secretary	Kazuya TAMADA (ITS Division, NILIM, MLIT, JAPAN)

MLIT: Ministry of Land, Infrastructure and Transport

NILIM: National Institute for Land and Infrastructure Management

Intelligent Transport Systems (ITS) Introduction Guide

Editors	Hiroshi MAKINO (ITS Division, NILIM, MLIT, JAPAN) Shunsuke KAMIJO (Institute of Industrial Science, University of Tokyo, JAPAN) Chi-Hyun Shin (Kyonggi University, Korea) Edward Chung (Queensland University. of Technology, Australia)
Assistants	Takahiro TSUKIJI (National Highway and Risk Management Division, Road Bureau, MLIT, JAPAN) Kazuya TAMADA (ITS Division, NILIM, MLIT, JAPAN) Tomoaki MIZUTANI (ITS Division, NILIM, MLIT, JAPAN) Takumi NISHIMURA (Transport and Socioeconomic Research Division, IBS, JAPAN) Hiromi KASUYA (Transport and Socioeconomic Research Division, IBS, JAPAN)

MLIT: Ministry of Land, Infrastructure and Transport

NILIM: National Institute for Land and Infrastructure Management

IBS: The Institute of Behavioral Sciences

Table of Contents

1.	Introduction	1-1
1.1	Introduction	1-2
1.2	Topic: What is ITS?	1-3
2.	Issues in Road Traffic.....	2-1
2.1	Urbanization.....	2-2
2.2	Increase in transport demand, and CO2 emissions	2-3
2.3	Exacerbation of Traffic Safety.....	2-6
2.4	Exacerbation of Traffic Congestion.....	2-7
3.	Components of ITS	3-1
3.1	Pattern of ITS Configuration	3-2
3.2	Vehicles (ITS Onboard Unit).....	3-3
3.3	Communications	3-7
3.4	Positioning	3-14
3.5	Mapping	3-19
3.6	Sensing	3-20
4.	Applications.....	4-1
4.1	Traffic Control.....	4-2
4.2	Traffic Signal Control	4-8
4.3	Electronic Fee and Toll Collection (EFC) System	4-14
4.4	Probe car data collection	4-27
4.5	Road Management Using Probe Car Data.....	4-32
4.6	Information Provision Services on Roads	4-37
4.7	Bus Location	4-43
4.8	Public Transport Priority System (PTPS)	4-45
5.	Introduction and Promotion of ITS	5-1
5.1	ITS Planning and Evaluation	5-2
5.2	Items to be studied at the time of ITS Introduction.....	5-10
5.3	Items to be studied to ensure the Smooth Promotion of ITS	5-20
5.4	Step-Up Approach to the Introduction of ITS	5-26
5.5	Training and Education.....	5-28
6.	Appendix: Acronyms	6-1

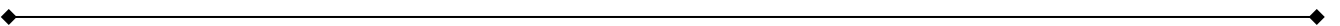
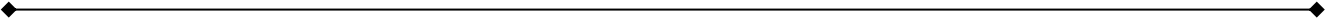

1. Introduction

1.1 Introduction

Roads are a core piece of infrastructure that supports the movement of people and logistics, forming the foundation of social and economic development and interconnecting cities, ports, projects and airports. But while road maintenance and improvements bring about economic development, the increased volume of traffic causes problems such as traffic accidents and congestion. In recent years the growth of population, progress of urbanisation and rapidly increasing car ownership in Asian countries has exacerbated the negative effects caused by cars, resulting in a massive increase of traffic accidents, congestion and environmental deterioration due to emission gas.

The Intelligent Transport Systems (ITS) is a new road and traffic system which combines information, communication, and control technologies to properly integrate drivers, vehicles and roads in a way that supports people driving. Its aim is to solve not only car traffic issues but also socioeconomic issues, which include ageing, a declining CBD, tourism vitalization, and sustainable economic development utilizing information communication technology.

This document will explain the elements of ITS, provide concrete applications to solve the issues and list measures to efficiently and effectively implement it as a working system in Asian countries. ITS places vehicles at the centre of the system as a moving object, rather than building a system in a factory or office. It uses sensing, positioning, mapping, communication and networks to solve issues by integrating them and then connecting people, vehicles and roads.

The ITS applications aim to solve the issues at three main levels: society, the road administrator and drivers. At a societal level, the applications would decrease accidents by way of safe driving support, as well as reduce traffic congestion by providing ongoing congestion information, in lowering the environmental impact. For the road administrator, hazardous locations and frequently congested areas could be easily identified by probe information collected from vehicles; this would enable the roads to be managed more efficiently and at a lower cost. Drivers would enjoy economic advantages such as reduced tolls, use of the route information and benefits such as nonstop toll payment and parking fee payment.

Some countries have attempted to implement ITS and experienced positive results. However, they have still come up against various issues which have inhibited its success, such as systems not being properly integrated, not having enough expertise, not establishing a master plan, or, importantly, financial restrictions.

In order to effectively introduce an ITS, it is important to select information communication technology and applications tailored to each country and region. This includes drawing up and efficiently promoting an appropriate introduction plan and project scheme, building consensus among related parties, and ensuring an adequate budget and system is in place.

We hope that this document would provide workable suggestions in solving common car traffic issues experienced around the world.

1.2 Topic: What is ITS?

Intelligent Transport Systems, or ITS, is a new transportation system which aims to resolve a variety of road traffic issues, such as traffic accidents and congestion, by linking people, roads, and vehicles in an information and communications network via cutting-edge technologies. It includes, for example, a road traffic information provision system in which road traffic information is collected via roadside sensors and then provided to drivers.

ITS provides people with a variety of convenient road traffic applications. In addition, the provision of new ITS applications through the use of a variety of information and communications technologies greatly contributes to the creation of new business opportunities and markets, as well as the vitalization of economic activities.

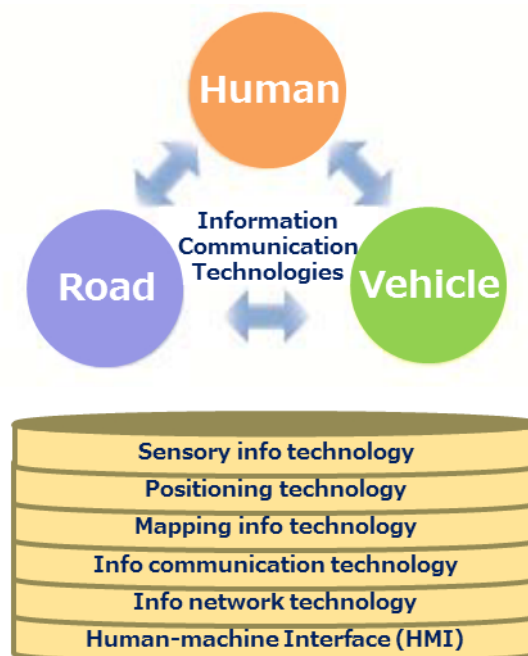

Figure 1.2-1 Components of ITS

The three most important components needed for establishing ITS are location, mapping, and communications.

An example of the component technology used for location includes the Global Positioning System (GPS) and the Galileo system, a system that is being promoted in Europe. As GPS receivers have become quite inexpensive, they are now extensively used on familiar information devices, such as car navigation systems and mobile phones.

Mapping is a technology that plots location information on a map and can be realized with the help of a digital map.

Communications can be realized via a variety of telecommunications and broadcasting technologies, such as FM multiplex broadcasting, mobile phones, and DSRC. This needs to be spelled out in full. As these communication media have varying characteristics, such as long-range or short-range, one-way or two-way, and free or fee-based, an optimal combination of communication media needs to be studied and selected according to the types of ITS applications.

It is also important to establish a common platform using ITS as the base for these information technologies for linking people, vehicles, and roads. To be more specific, in addition to establishing common communication infrastructures, common communication methods, and common data formats, among other things, it is important to establish onboard unit, roadside units and the systems, among other things, that are compatible with all available applications.

It is expected that the establishment of a common platform will contribute to the improved scalability of applications and improved user convenience, such as securing the compatibility of single onboard unit with multiple applications.

2. Issues in Road Traffic

2.1 Urbanization

Globally, population in urban areas increased at a far more rapid rate during the 20th century than those in rural areas. According to the United Nations, 30% of the world's population lived in urban areas in 1950; today that figure stands at 54%. The UN expects that by 2050, 66% of the world's entire population will live in cities.

Today, the world's largest city is Tokyo; followed by Delhi, Shanghai, Mexico City, Mumbai, and Sao Paulo. It's predicted that by 2050, urban populations in Asia and Africa in particular will have increased exponentially.

Assuming these predictions are correct and urbanization continues to increase, it is also fair to assume that road traffic issues, such as congestion and its impact on the environment will only worsen.

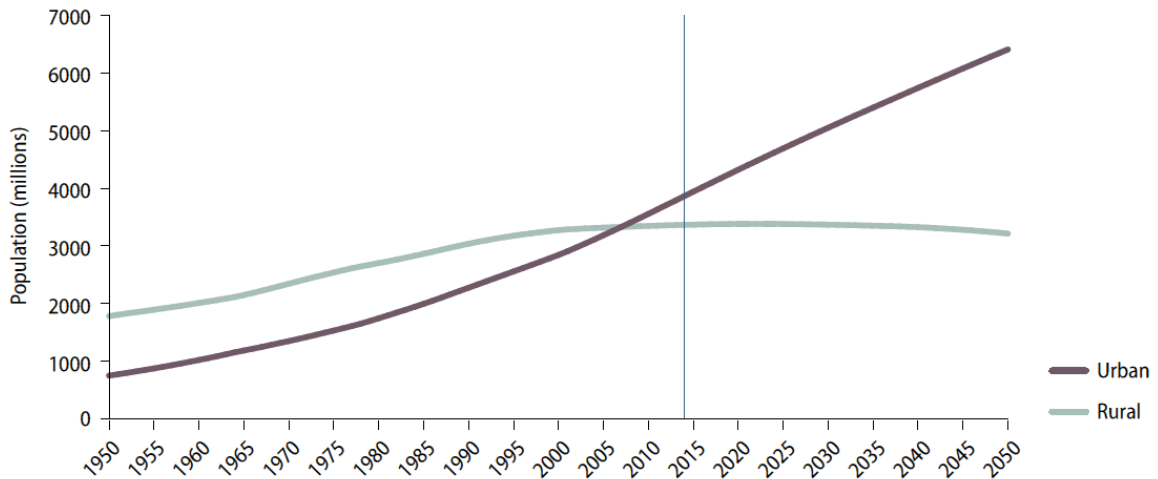

Figure 2.1-1 Urban and Rural Population of the World, 1950-2050

(Source: UN, World Urbanization Prospects)

2.2 Increase in transport demand, and CO2 emissions

According to estimates by the International Transport Forum (ITF), road and rail passenger traffic will increase by 120%–230% by 2050 worldwide (estimates vary depending on future oil prices and urban transport policies). The increases are predicted to take place mainly in non-OECD countries where passenger traffic is expected to increase by 250%–450%. As a result, worldwide CO2 emissions from surface passenger transport are estimated to increase by 30%–110%.

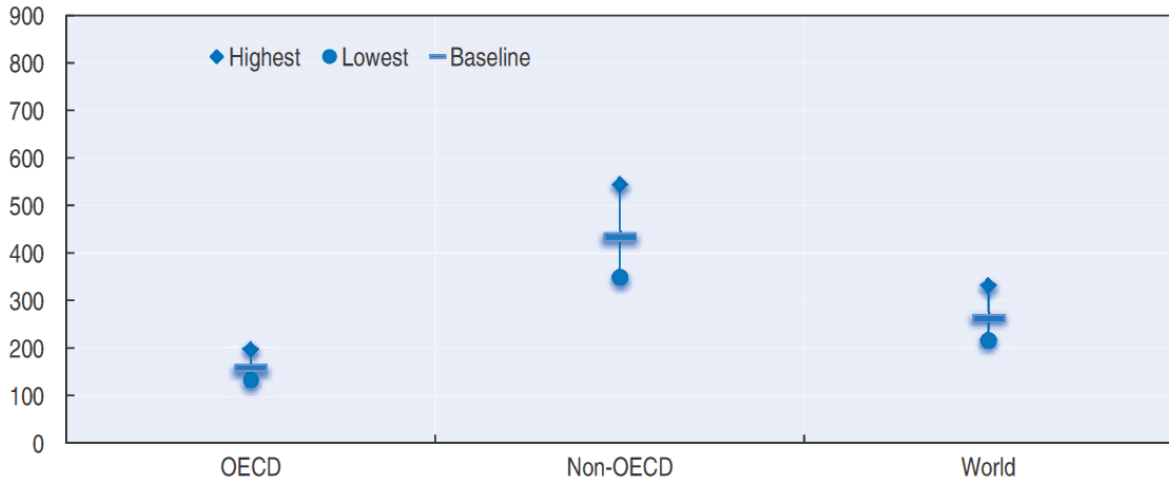

Figure 2.2-1 Passenger Transport in vehicle-kilometers, 2050 (2010 = 100)

(Source: ITF, ITF Transport Outlook 2015)

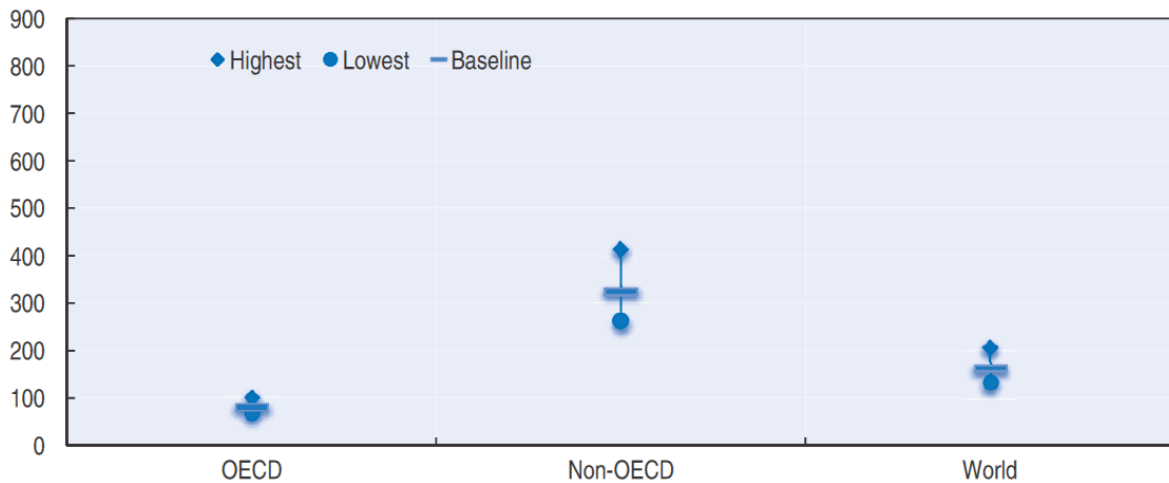

Figure 2.2-2 CO2 Emissions from Surface Passenger Transport, 2050 (2010 = 100)

(Source: ITF, ITF Transport Outlook 2015)

Worldwide freight traffic by road and rail is estimated to increase by 230%–420% by 2050, increasing associated CO₂ emissions by 140%–350%. Again, the increase in CO₂ emissions associated with worldwide surface freight traffic is expected to originate in non-OECD countries. By 2050, Asian countries, including China and India, are anticipated to account for over 50% of global surface freight traffic (35% at present).

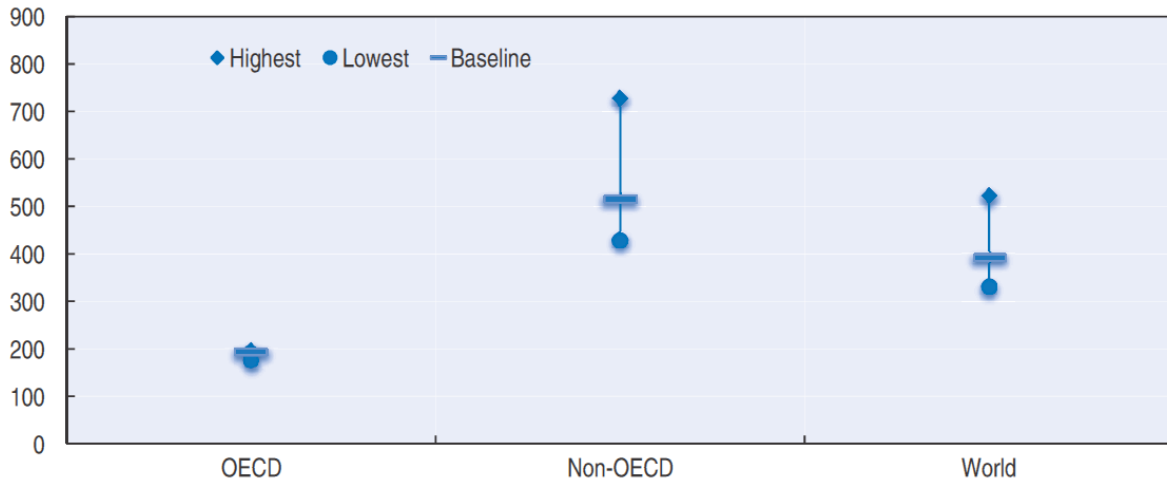

Figure 2.2-3 Surface Freight Transport in tonne-kilometers, 2050 (2010 = 100)

(Source: ITF, ITF Transport Outlook 2015)

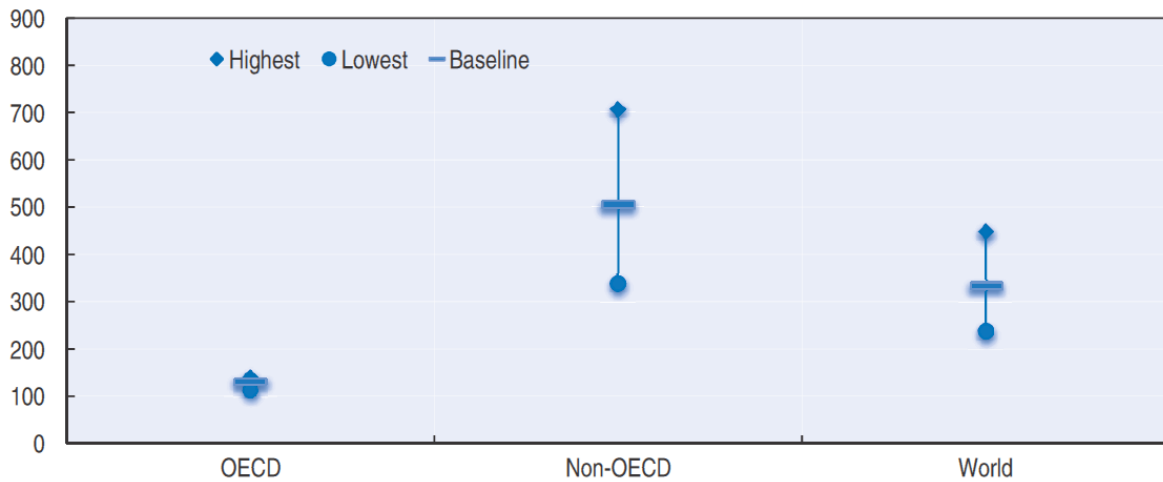

Figure 2.2-4 CO₂ Emissions from Surface Freight Transport, 2050 (2010 = 100)

(Source: ITF, ITF Transport Outlook 2015)

According to the International Energy Agency (IEA), global CO₂ emissions reached 32.2 billion tonnes in 2013. Approximately 23% of CO₂ emissions are derived from the transport sector, which includes air, ship, rail, and road traffic. Of the CO₂ emissions caused by the transport sector, three quarters are of those are caused by road traffic.

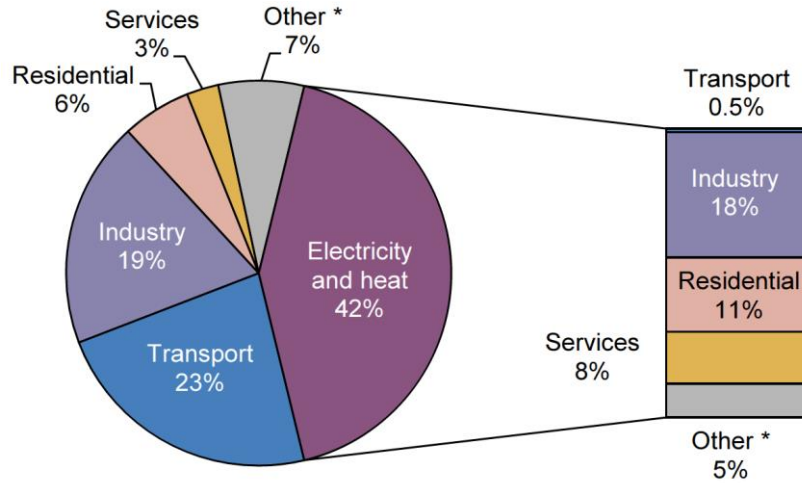

Figure 2.2-5 World CO₂ Emissions by sector in 2013

(Source: IEA, CO₂ Emissions from Fuel Combustion)

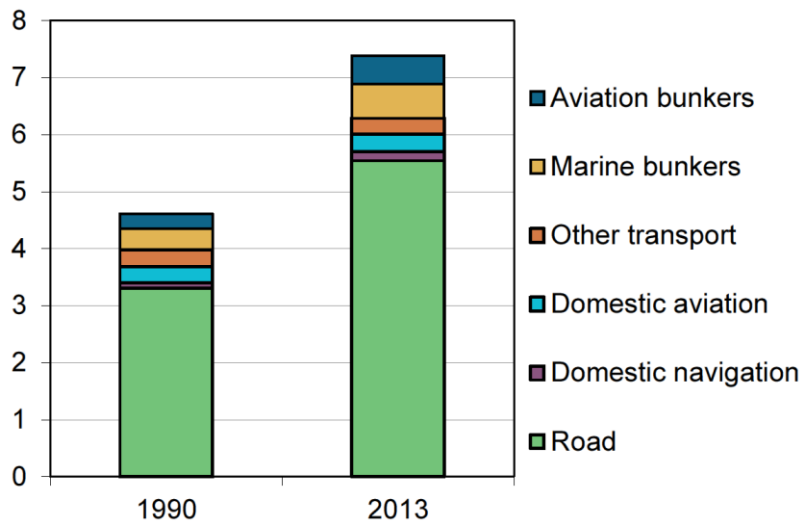

Figure 2.2-6 CO₂ Emissions from Transport

(Source: IEA, CO₂ Emissions from Fuel Combustion)

2.3 Exacerbation of Traffic Safety

Approximately 1.3 million people have lost their lives in traffic accidents globally. A further 20 to 50 million people have been injured. Traffic accidents are the primary cause of death for young generations worldwide. A vast majority of these fatal accidents and injuries happen in developing countries where awareness and provision for traffic safety are relatively low. In addition, almost half of the victims are vulnerable road users such as pedestrians, bicycle users and motorcyclists. Along with the grief caused by traffic accidents, they cause immense economic losses corresponding to about 1%–3% of GNP.

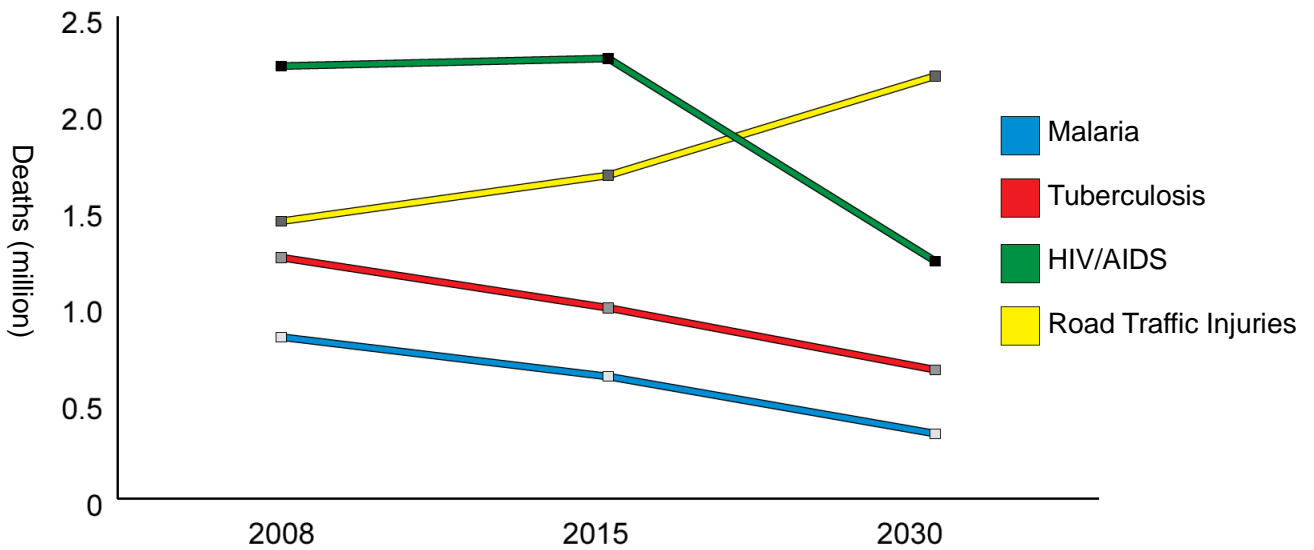

Figure 2.3-1 Projections of Global Mortality (All Ages) to 2030

(Source: WHO, Global Burden of Disease 2008)

2.4 Exacerbation of Traffic Congestion

The European Union (EU) predicted in its White Paper on Transport (2011) that economic losses caused by traffic congestion will increase by 50% in EU nations by 2050. The situation is far more serious in Asian megacities. The World Bank estimated in 2014 that the economic costs of delayed deliveries caused by traffic congestions in Kuala Lumpur alone corresponded to up to 1.8% of Malaysian GDP.



Figure 2.4-1 Traffic Congestions in Asian Cities

(Source: Meeting Document for Council on Infrastructural Development)

3. Components of ITS

3.1 Pattern of ITS Configuration

The patterns of ITS configuration may include (i) two-way communication (active system), (ii) one-way communication (passive system), and (iii) telematics systems, among other things.

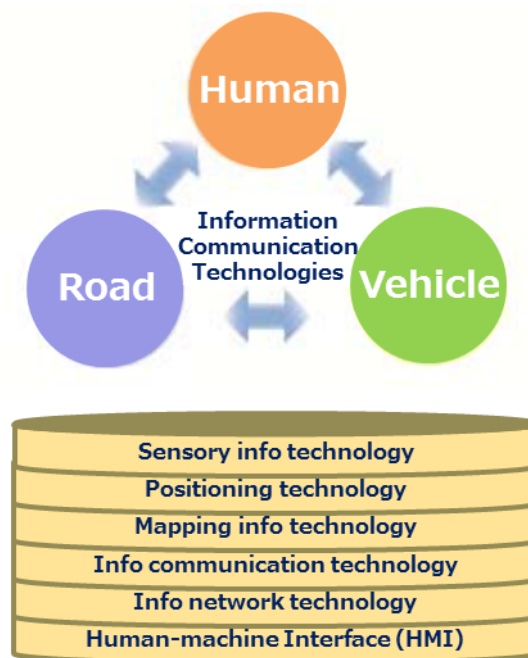

Figure 3.1-1 Components of ITS

The chief characteristic of the active system (i) is that it is readily deployable to a wide variety of applications via interactive communication.

On the other hand, the chief characteristic of the passive system (ii) is that the installation of onboard unit is simple and low cost.

The telematics system (iii), which was adopted in Europe for the charging of tolls to trucks, among other things, is advantageous in charging fees for a wider geographic area as it does not require the installation of roadside infrastructures.

In many of the countries where there are a large number of relatively low-income road users, a system that allows the use of low cost onboard unit has been adopted. However, there have disadvantages that leave a heavier burden on backyard systems, incurring substantial costs and forcing a road user to purchase new onboard unit when a new application is added. It is recommended that, when studying the adoption of the pattern of ITS configuration, its future scalability be taken into account.

3.2 Vehicles (ITS Onboard Unit)

3.2.1 Essential Functions of Onboard Unit

Onboard unit (OBU), which is mounted on a vehicle, is expected to play the following roles in ITS: communicate with roadside infrastructures, transfer necessary information, process the payment of tolls, and act as an interface (as a bridge) between road infrastructures and a driver, amongst other things.

To be more specific, the essential functions of onboard unit are summarized as follows:

Table 3.2-1 Functions of Required for ITS OBU

Function	Explanation
Instruction response function	The function which returns user's response to the command received by ITS OBU to roadside system using the button of ITS OBU
Memory access function	The function which loads or writes data stored in memory of ITS OBU according to the command from roadside system
IC card access function	The function which sends or receives payment information according to the command from roadside system
Push-type information delivery function	The function which executes transaction automatically according to the type of contents from roadside system There are two types of method: one is the method which delivers contents themselves (contents push type) and the other is the method which delivers the location to contents (URL, etc.) and acquires the content by HTTP or something (pseudo push type).
Common security function	The function which certifies equipment by cross certification between ITS OBU and roadside system and is compatible for encrypted communication using the key exchanged through cross certification

3.2.2 Concept to Ensure Future Scalability

When implementing ITS applications, it is important to take into account ITS compatibility with possible future applications. If it is necessary to install new onboard unit in a vehicle or to make modifications to the existing onboard unit, when a new application is added, roadside units must check whether relevant applications are installed in onboard unit, etc., thus making procedures for implementing applications more complicated and causing a problem in managing the sound implementation of applications. In addition, the replacement of onboard unit and addition of applications to onboard unit results in causing undue burden to users, etc., in terms of time and cost.

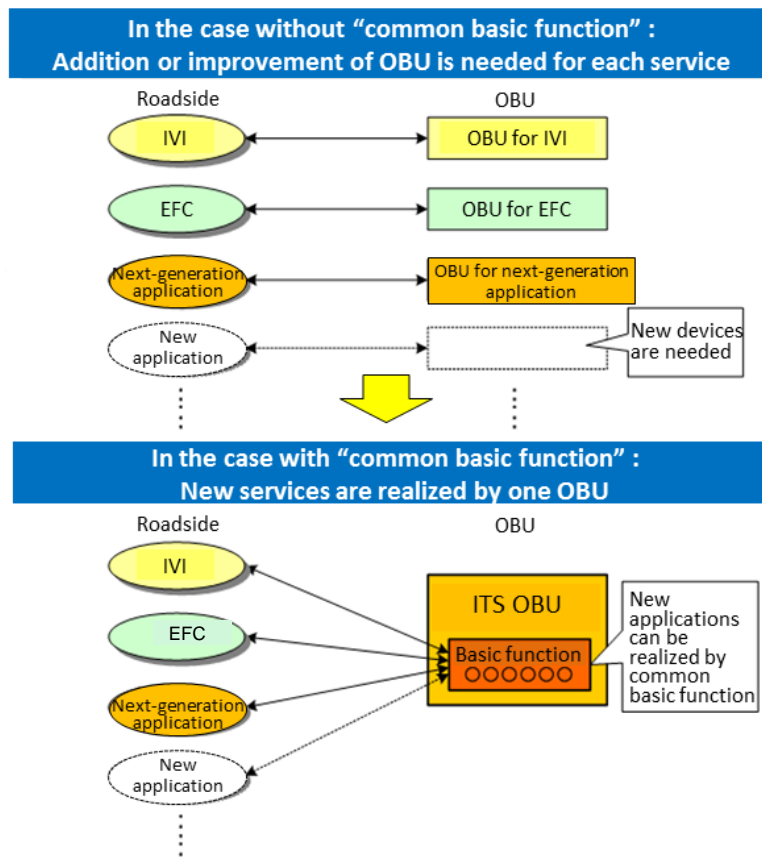

Figure 3.2-1 Concept to Ensure Future Scalability

[Reference] ITS Onboard Unit in Japan

In Japan, it has been agreed through discussions with automotive manufacturers that ITS onboard unit is initially equipped with several common basic functions that are considered to be required once multiple applications become available. Specifically, such common basic functions include command/response function, memory access function, an IC card access function, a push-type information delivery function, onboard unit ID communication function, and onboard unit's basic command function. An overview of each of these functions is outlined as follows:

In addition, by developing and installing roadside systems that are capable of utilizing these basic functions of ITS onboard unit, it is possible to implement such new applications without new onboard unit or modifications to the existing onboard unit.

As a specific example of an ITS onboard unit that meets the above criteria, ITS onboard unit that has been put to practical use and has been widely used in Japan is shown below.

In Japan, ITS onboard unit with a large liquid crystal display (LCD) screen and speakers which GNSS and DSRC unit capable of processing payments by credit cards are combined is put to practical use and sold on the market.



Figure 3.2-2 An example of ITS OBU in Japan (From Panasonic Corporation HP)

ITS onboard unit incorporates some notable functions, some new, such as Internet connections, processing payments by credit card, voice commands, push-type information delivery and probe. This is in addition to the enhancement of IVI' existing function so as to provide traffic congestion information over a wider geographical area due to the increased communication capacity. It is now possible to develop a variety of applications for use when a vehicle is in operation, parked, or stopped, by combining these basic functions. (See Figure 3.2-2)

Table 3.2-2 Common basic function of ITS OBU (Basic API, Basic security function)

EFC	Expressway toll payment (Killer application)
Car navigation system (IVI)	Navigation (Killer application)
New IVI	Broader and easier to understand
AHS	Safe driving information provision (World first)
Probe car data	IVI / enhancement of safe application is enabled
Internet	On-demand application (Sightseeing information, update of map)
Credit card payment	Cashless payment, establishment of business model
Voice guidance	Easy roadside broadcast, sightseeing guide

A car navigation system will most likely evolve as a device that primarily operates as the brain of a vehicle, in conjunction with the vehicle information held by a vehicle and the operation of a vehicle. Importantly, a car navigation system will most likely evolve by incorporating communication functions where it is weak; based on applications that enable it to operate in conjunction with EFC, which processes the payment of tolls while a vehicle is in operation, AHS, which provides information on safe driving, and electric vehicle (EV) charging information.

It is also expected that smartphones will create a new market for car navigation systems for casual users/drivers who are not interested in purchasing a car navigation system.

That said, it is necessary to fully study the development of human-machine interfaces (HMI) assuming that a car navigation system is used when a vehicle is in operation. We advise aiming to link car navigation system to functions, such as EFC and AHS, after the development of HMI.

The important thing is that, as in the case of cloud applications which have been popular in the media recently, information is seamlessly transferred and shared regardless of what devices are being used. For example, your trip by vehicle will likely go like this: you research your destination at home prior to your trip, determine a travel route, tourist attractions to visit and where to stay. All this information is transferred to a car navigation system. The car navigation system then guides you to your destination smoothly and safely, avoiding traffic congestion along the way by utilizing IVI and EFC. At your destination, you get information on tourist attractions and other helpful tips via a smartphone so that you can enjoy sightseeing.

In other words, differences in communication standards and communication devices do not matter much. The important thing is that the contents and applications that users need are seamlessly provided.

3.3 Communications

3.3.1 Comparison of Radio Communication Technologies

There are a variety of means of communication that connect roads (roadside systems) with vehicles (ITS onboard unit), such as mobile phones, DSRC and FM multiplex broadcasting. As each of these means of communication has its own unique characteristics, it is advisable to use the radio communication technology that best suits the characteristics of applications.

That said, it is uneconomical in terms of costs to install a device that is compatible with the relevant communications standards for each application. Therefore, when establishing ITS, it is important to select the optimal means of communications by taking into account the required specifications of applications and other relevant matters.

Technologies that connect roads and vehicles are roughly divided into communications technologies and broadcasting technologies.

The comparison of communications and broadcasting technologies is shown as follows:

Table 3.3-1 Difference between “communications” and “broadcasting” technology

	Communication	Broadcasting
Information provided area	Relatively small range (dependent on method)	Relatively wide range (dependent on method)
One way / Two way	Two way (One way in some cases)	One way
Suitable application type	- Information provision according to individual user - Applications which require two way communication	- Wide range and concurrent information provision

In the case of ITS communications, it is necessary to study communication technologies in terms of capacity levels, areas covered, response time and reliability (requirements for communication reliability are more stringent, especially in the case of applications related to safe driving assist and the processing of toll payments). Specifically, as requirements for communication technologies are more demanding in the case of remote road-to-vehicle communications, such as those related to safe driving assist under high speed operation, and vehicle-to-vehicle communications, it is important to adopt highly reliable communication technologies with short response time (such as DSRC). (See Figure 3.3-1)

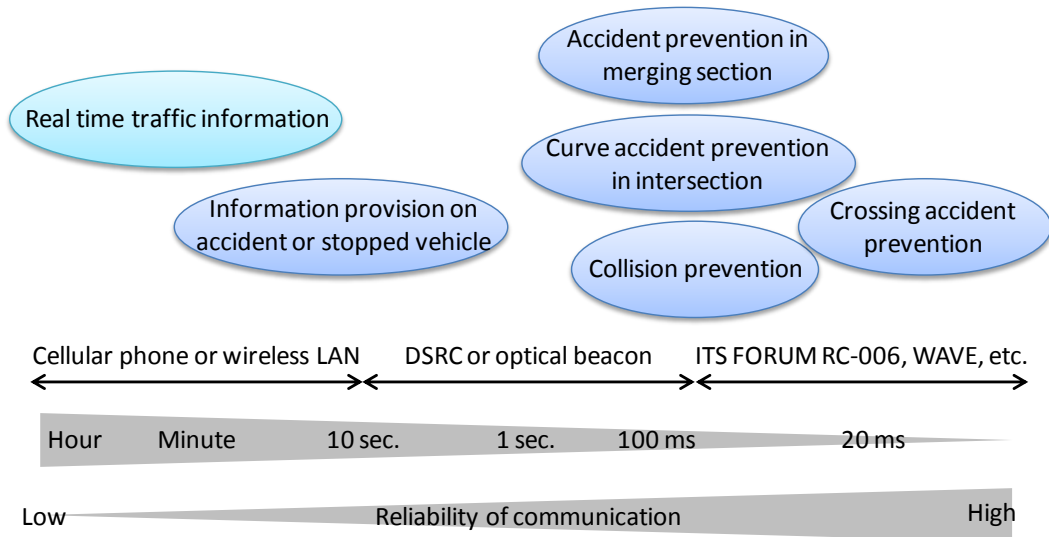

Figure 3.3-1 Relation between response time / reliability of communication and ITS applications

Table 3.3-2 Characteristics and use of wireless communication technology

Wireless communication technology		Capacity*	Speed*	Stability	Communication expenses	Use in ITS	
Broadcasting	Wide range	Digital broadcast FM multiplex	Large	Slow	○	○	- Car navigation system
	Communication	Wide range	Cellular network	Large	Slow	○	×
WIMAX			Large	Slow	×	×	
LTE			Large	Slow	×	×	
Small range		WI-FI (2.4GHz)	Large	Slow	×	×	- Not for EFC because of poor speed. - Internet during stop
		DSRC	Middle	Fast	○	○	- EFC and safety applications - V2V, V2I - Used for internet during stop
Optical (Infrared communication)	Small	Fast	△	○	- Information provision and collection by lane		

Note : *In the table above, “capacity” indicates “maximum throughput,” and “speed” indicates “speed of corresponding moving vehicle”

*Besides above, communication area in the areas introducing ITS need to be considered.

[Reference] Overview of DSRC Technology (V2I communication technology in Japan)

DSRC which is used in EFC, a typical application of “Smartway,” is explained here.

An EFC system must ensure a high level of security because it handles information relating to payment of tolls on toll roads, as well as personal information relating to traffic congestion, amongst other things. An EFC system must be also highly flexible and reliable as it has to cope with a variety of ways in which toll roads are administered (toll rates set according to the distance travelled, uniform toll rates, etc.) and enormous traffic volumes.

The active DSRC system adopted in Japan, which is compliant with the ARIB STD-T75 standard (an international standard) fully satisfies these requirements and consists of the characteristics described below. This is why the DSRC technology has been adopted as a means of communication for the EFC system in Japan. The DSRC technology is also suitable for safe driving assist systems as free flow and expanded functions.

(i) High Reliability

By mounting an oscillator onto onboard unit, the active DSRC system becomes less susceptible to electromagnetic interference or obstruction coming from its surroundings, thereby ensuring a roadside unit's high level of reception. The active DSRC system is an optimal two-way communication technology for the EFC system and other applications that require high reliability.

(ii) Wide Communication Areas

The active DSRC system ensures a wide communication area of more than approximately 30 meters (smaller communication areas can also be set as required), which enables a roadside unit to have a two-way communication of a large amount of data with a number of vehicles.

(iii) High Scalability due to Adoption of Active DSRC System

The active DSRC system, which is compatible with full duplex communications, can transmit high-speed, high-volume data transmissions. The active DSRC system can be integrated into different EFC systems used in other countries or regions, and it also can be applied to parking payment systems, traffic or travel information systems, cruise assist systems, probe car data systems and commercial vehicle operation management systems.

(iv) Effective Use of Frequency

In the case of the active DSRC system, the same frequency can be used for short installation distances, thus allowing the effective use of limited frequencies.

Table 3.3-3 Comparison of EFC system between Japan, EU and North America

	Frequency	Communication method	Interactive communication type	Transmission speed
Japan	5.8GHz	Active	Full duplex / half duplex	Outbound : 4Mbps Inbound : 1Mbps
EU	5.8GHz	Passive	Half duplex	Outbound : 500Kbps Inbound : 250Kbps
North America	915MHz	Active	Full duplex	Outbound : 500Kbps Inbound : 500Kbps

[Reference] Overview of ARIB STD-T75 Standard

- ARIB STD-T75 is the standard applicable for EFC and information shower application enlarged including ARIB STD-T55.
- It is used for current EFC and applicable for other applications. Larger number of channels was saved by making the frequency half of ARIB STD-T55.
- New channels were added, and 14 channels (7 for inbound, 7for outbound) became available. Adoption of QPSK and error correction sign enhanced speed and reliability of communication.
- Two-way communication with 4 Mbps is available for 56 vehicles (maximum) in 30m application area.
- It is reflected in ITU-R recommendation 1453 as an international standard.

Table 3.3-4 Overview of ARIB STD-T75 Standard

Access method	TDMA-FDD	
Frequency	5.8GHz band	
TDMA multiplex	8, 4, 2	
Number of channel	Inbound:7, Outbound:7	
Interval of send and receive frequency	40MHz	
Modulation method	ASK (Amplitude Shift Keying)	$\pi/4$ shift DQPSK (Differential Quadrature Phase Shift Keying)
Transfer speed	1024kbps	4096kbps
Access control method	Adaptive slotted ALOHA method	
Communication available speed	180km/h (maximum)	
Error correction sign	CRC	BCH sign

ARIB STD-T85 has been drawn up utilizing the extended communication specification related to DSRC Application Sub-Layer (ASL) as a standard specification in order to make multiple applications executable on the DSRC system prescribed in the DSRC system standard, ARIB STD-T75. ARIB STD-T85 provides a logical structure that makes it easier to use onboard devices and apply them to business processing systems that have not been targeted, such as applications using the Internet.

[Reference] Overview of Vehicle-to-Vehicle Communication Technology

Vehicle-to-vehicle communication technologies have been trial tested for practical applications in Japan and the United States, amongst other countries. An example of Japan's vehicle-to-vehicle communication technology (ITS FORUM RC-006) is depicted blow.

[Reference] Overview of Vehicle to Vehicle Communication Technology

A vehicle-to-vehicle communication technology is expected to be deployed to applications relating to safe driving assist and vehicle operation. However, the challenge is that the positive effects of the introduction of a vehicle-to-vehicle technology do not appear until the technology becomes widely used nationwide. This is because they are dependent on the penetration rate of the technology. (The probability of materialization of communication is proportional to the square of a penetration rate of the technology.)

- ITS FORUM RC-006 is the guideline which describes the specification of V2V communication system aimed at safe driving support, by ITS information communication forum.
- It is issued to use 700 MHz effectively, which became available by the analog broadcast end.
- It is aimed at one-way broadcast and being available for hundreds of vehicles.
- Application to safe system is expected because of UFH
- Consideration of effective use is necessary because there is only one available channel.
- Use for V2V communication was expected at first, now use for V2I communication is expected.

Table 3.3-5 Specification of ITS FORUM RC-006

Access method	CSMA / CA method	
Frequency	720MHz band	
Number of channel	1	
Modulation method	OFDM	
	Symbol modulation method	BPSK, QPSK, 16QAM
	Number of subcarrier wave	52
	Effective symbol length	8.0 μ s
	Guard interval length	1.6 μ s
	Occupancy band	8.3MHz
Transfer speed	18Mbps (maximum)	
Packet length	1,500octet (maximum)	
Frame cycle	100ms or its integral multiple	
Error correction	Convolutional code with constraint length 7, R=1/2, 3/4	
Aerial power	10mW / 1MHz (maximum)	
Communication available speed	Relative speed between 0km/h and 140 km/h	

Source: ITS Forum "Experimental guideline for driving support communication system using 700MHz band"

ARIB STD-T109 is a standard for communication between cars drawn up using ITS FORUM RC-006, an experiment guideline in the 700 MHz range.

In an environment where there are a lot of cars on the road, access control is required to prevent packets from sending from these cars simultaneously. Therefore, ARIB STD-T109 uses CSMA/CA, an access control method used in wireless LAN.

ARIB STD-T109 is a common communication system that time-shares one channel in the 760 MHz range and operates communication between cars and between a road and a car.

[Reference] Issues on Frequency Allocation for V2V and V2I communications

In general, allocating frequency is a high priority issue in radio utilization, as well as in ITS application. Currently, key frequency bands being discussed globally are: 5GHz band mainly allocated to V2V and V2I communications, and 79GHz band considered to be allocated to millimeter wave radar for object sensing.

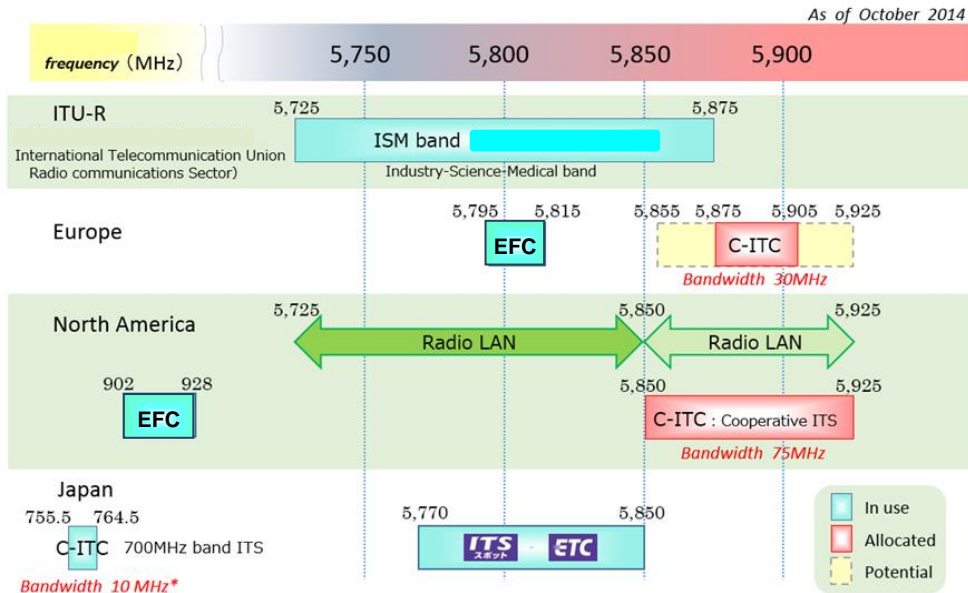

Figure 3.3-2 Frequency Allocation of 5.8GHz-5.9GHz bands
 (Source: Presentation at the UTMS Seminar, January, 2014)

The figure above shows the comparison of 5.8GHz-5.9GHz frequency band allocation in Europe, North America, and Japan, respectively. In Japan, 5.77GHz-5.850GHz are allocated to Electronic Fee Collection (EFC) and ETC2.0 (ITS Spots) and widely used already.

Although 5.875GHz-5.905GHz band in Europe, and 5.850GHz-5.925GHz band in North America are allocated to V2V and V2I communications of C-ITS(Cooperative ITS), they have not been widely used yet. Then, wireless communications without any permission required such as Wi-Fi required wider bands and share the band with ITS applications.

Today, 5.8GHz-5.9GHz band is allocated as industry-science-medical (ISM) band, or national defense, and weather radar. However, sharing Wi-Fi communications without any authorization would cause frequency interference, and become serious problems in ITS applications which require immediacy and reliability. For instance, there are discussions on pros and cons of allocating 5.725GHz-5.875GHz band to broadband wireless communications such as Wi-Fi in EU nations. Therefore, countries face an urgent issue to allocate 5.8GHz-5.9GHz band to ITS applications and launch new services.

3.4 Positioning

3.4.1 Necessity for Location Information for ITS

ITS is designed to resolve not only vehicle/traffic issues, such as traffic accidents, traffic congestion and adverse effects on the environment - but also social issues, such as the aging of population, urban issues, promotion of tourism, and sustainable economic development.

The fact that ITS is a mobile object (vehicle), rather than a system established in a manufacturing plant or in an office plays a central role in its potential for success.

The basic structure of ITS consists of five components: sensing, positioning, mapping, communication, and networking.

In other words, mechanisms for the distribution, storage, and processing of information work collaboratively to operate a variety of applications by effectively utilizing these five technologies; sensing technology for collecting information on external circumstances via camera or radar installed on a moving object or road infrastructures; positioning technology for identifying the location of a moving object; mapping technology for plotting and displaying the location on a map; communication technology for linking a moving object to the Center (a base station), as well as a moving object to other moving objects; and networking technology. (See Table 3.4-1 Driving support applications using map)

In addition, in recent years, increasing importance has been placed on traffic probe information applications which utilize information collected from a vehicle. As probe information applications require highly accurate location information, there is a higher requirement for highly accurate location identification technologies.

3.4.2 Accuracy of Location and Identification Technology Required for ITS

Of all the moving objects, vehicles are operated in a very limited space called a "road." While airplanes fly in the air where there are no obstacles and ships cruise on open oceans and seas, vehicles are often operated in a confined space surrounded by obstacles such as inside tunnels, elevated highways, underground roads and parking facilities. Despite this, the demand for low-cost location identification technology is much higher in the case of vehicles compared to airplanes or ships because most of the vehicles are owned by individuals.

It is because of this high demand that the required specifications of location identification technology in a vehicle are low cost and the capability to accurately identify location even in a confined space surrounded by obstacles.

Table 3.4-2 summarizes the relationship between the accuracy of location information and ITS applications. In addition, Table 3.4-3 lists the location identification technologies that are now commonly used.

GNSS is widely used as an ITS application due to cost advantages of roadside units and onboard equipment. However, GNSS has disadvantages such as the inability to accurately identify location such as inside tunnels, areas mountainous or surrounded by buildings, to name a few – and it's susceptible to error by over a meter. In order to establish an application using relative locations of pedestrians and vehicles, accuracy of technology in location identification needs to be further improved. Projects to improve high-precision positioning include EU's Galileo System, and Japan's Quasi-Zenith Satellite System (QZSS). Other approaches to improve positioning accuracy by using correction data from roadside units are important in positioning at enclosed locations such as tunnels, indoor parking, etc. where satellite acquisition is difficult.

Table 3.4-1 Driving support applications using map

Mode	Targets		Map data		sensor / communication	
			Static information	Dynamic information		
1. Road information provision	1-1. Speed information	1) Speed regulation	Speed regulation			
		2) Safe speed	Information on hazardous section			
		3) Congestion at sag	Information on sag section, speed			
	1-2. Traffic regulation information	1) Stop section	Information on stop			
		2) One-way lane	Information on one-way			
	1-3. Lane information	1) Driving lane	Information on regulated lane, changeable lane	Changeable information		
	1-4. Sign information	1) Sign	Sign information			
	1-5. Traffic information	1) Congestion		Congestion information		
		2) Workzone		Workzone information		
		3) Special traffic regulation		Special traffic regulation information		
	1-6. Road surface information	1) Flooding, freezing		Flooding, freezing, weather information		
	1-7. Zone information	1) Traffic calming zone	Information on traffic calming			
	1-8. Weather information	1) Rain, snow		Weather information		
		2) Visibility		Visibility information		
2. Information provision on surroundings	2-1. Surrounding vehicle information	1) Merge	Merge section		Merge information	
		2) Overtake	Overtake prohibited section		Surrounding vehicle information	
		3) Direction change	Direction change prohibited section		Surrounding vehicle information	
		4) Oncoming vehicle	Road width		Oncoming vehicle information	
		5) Tram	Orbit information, availability of orbit		Tram information	
	2-2. Intersection information	1) Straight	Detail information on intersection		Oncoming vehicle information	
		2) Right turn	Detail information on intersection		Oncoming vehicle, pedestrian information	
		3) Left turn	Detail information on intersection		Oncoming vehicle, bicycle information	
	3. Vehicle control	3-1. Vehicle characteristics control	1) ACC (adaptive cruise control)	Gradient of road, curvature		Distance between leading vehicle
			2) Shift control	Gradient and curvature of road	Roadsurface information	
3) Suspension control			Gradient and curvature of road	Roadsurface information		
4) Light control			Gradient and curvature of road			
5) Stability control			Gradient and curvature of road	Roadsurface information		
6) Electric power control			Gradient of road, charge area	Roadsurface information		
3-2. Vehicle control		1) Lane keep	Lane information (branch, merge section)		Lane information	
		2) Speed control	regulation speed, dangerous speed	Roadsurface information		
		3) Stop	Information on stop			
		4) collision avoidance	Road shape	Roadsurface information	Distance between leading vehicle, relative	
4. Mobility support	4-1. Environmental information	1) Reduction of CO2 emission	Information on gradient and curvature of road and speed	Congestion information	Fuel consumption information	
	4-2. Traffic node information	1) Parking lot	Parking lot information (location, operating time)	Occupancy, parking location		
		2) Park and ride	Parking lot information (location, public transportation)	Operation of public transport, occupancy, parking location		
		3) Multi modal	Traffic node information (parking lot, connection)	Operation of public transport, occupancy, parking location		

Source: ITS Japan next generation digital road information committee
 "Report on activities of next generation digital road information committee in 2009"

Table 3.4-2 Accuracy of location information required for ITS applications

Accuracy of location information	Relation with road	ITS application
±10m	Route	Route guidance
±1m	Inbound / outbound	Road information provision (alert)
±0.1m	Lane, stop line, vehicle, human	Safe driving support, vehicle control, V2V cooperation, V2P cooperation

Table 3.4-3 Comparison of generally used positioning technology

Positioning technology	Accuracy	Characteristics
GNSS*	± several meters	<ul style="list-style-type: none"> - Recognize position on earth using four GNSS satellites out of 24 around earth and receiver. - Cannot recognize position in places where GNSS wave doesn't reach such as tunnel. - High accuracy will be realized by correction using QZSS (Quasi-Zenith Satellite System)
Mobile base station	± several hundred meters	<ul style="list-style-type: none"> - Recognize position by ID of base for cell-phone and PHS and strength of wave from the base.
RFID	± several centimeters	<ul style="list-style-type: none"> - Accuracy is high - Recognize position by reading RFID tag on roadside. - There is an example of automated driving experiment using similar method (magnetic nail)
Wireless LAN	± several meters	<ul style="list-style-type: none"> - Recognize the position of wireless LAN client by arriving time and strength of wireless LAN wave. - Only in the vicinity of wireless LAN base station.

*Technologies for correcting GNSS's location identification include correction technologies utilizing ground-based infrastructure beacons, correction technologies utilizing information from dead-reckoning (DR) sensors, such as compasses, gyroscopes and wheel pulses equipped in onboard unit or vehicles, and correction technologies using digital road maps.

[Reference] Highly accurate positioning using the Quasi-Zenith Satellite System

The Quasi-Zenith Satellite System is a satellite positioning system developed in Japan, which performs positioning highly accurately using the same frequency (1575.42 MHz) signal as that of the GNSS and complementing the GNSS.

The geostationary orbit is a circular orbit looking as if it stopped from the ground because it stays on the same longitude by moving at the same speed as that of the earth's rotation. An inclined geostationary orbit is called the Inclined Geosynchronous Orbit. It forms a figure of eight in the south and north from the earth. The quasi-zenith orbit is an orbit that can stay longer in the northern hemisphere by making the inclined geosynchronous orbit elliptical.

(1) GNSS compensation

A quasi-zenith satellite can stay for 13 hours in the northern hemisphere. The positioning system is planned to include three quasi-zenith satellites and one geostationary satellite. Any one of the three satellites launched to different quasi-zenith orbits is planned to cover areas around the vertex of Japan, but only one satellite is used now. Though four satellites are required for positioning, it is not uncommon to have less than four satellites on the LOS (line of sight) between buildings. As one more satellite of LOS can ensure they are in the vertex, positioning between buildings can be improved.

Even a signal from a LOS satellite has an error in the quasi-distance due to multiple paths. However, a satellite with a higher elevation angle can emit an electric wave which then reflects a wave that more easily reaches near a building, than one with a lower elevation angle. This means that in the centre of a road distant from a building, a signal from a satellite with a higher elevation angle like a quasi-zenith satellite is insulated from the influence of multiple paths - and less influenced by positioning of a car navigation system. A quasi-zenith satellite stays around the vertex in Japan and Australia while it does not appear in South-East Asian countries but it can ensure its significance of existence as a satellite with a higher elevation angle.

(2) GNSS reinforcement

As a signal of a GNSS is sent from space of 20,000 km or more above the ground, it is faint. An electric wave is difficult to reach and has an error due to the influence of various natural environments, surface topography, and ambient radio wave environments. GNSS reinforcement aims at realizing highly accurate positioning by giving a quasi-zenith satellite's original reinforcement information. A quasi-zenith satellite is expected to provide highly accurate positioning anywhere nationwide as it sends an unaffected signal from directly above.

3.5 Mapping

Positional data need to be associated with map data. Obtaining positional data alone would not provide the location of a moving object, or route search function unless positional data are linked with map data. A number of map data are required for ITS: base map data, road network data (link/node), and information on the above data connected, road characteristics data (traffic restriction, stop line, sidewalk, interchange, etc.), static information (landmark, warning, etc.), and dynamic information (traffic restriction, road surface, weather, etc.). These data turn into useful information to drivers through applications such as route search. Therefore, completeness, accuracy, and “freshness” are required for data in each application. In particular, freshness is critical in map data for user convenience. A method to keep the map as up-to-date as possible with information which is renewed every day is the key. If a route search application does not recognize a newly opened road section, the service would not be provided to users. How to update map data is fundamental in ITS application.

The concept of Dynamic Map in terms of international standards, currently under discussion, is a mechanism to build a map overlaid with static information such as landmark, and dynamic information such as local information and traffic signal. In order to realize driving support service, systems of linking the base map with static, quasi-static, quasi-dynamic, and dynamic data is essential.



Figure 3.5-1 Concept of Dynamic Map

(Source: SIP-adus)

3.6 Sensing

3.6.1 Sensing Technology for Further Improving Traffic Efficiency

In order to further improve traffic efficiency, it is important to fully understand the mechanism of traffic congestion and detect the causal factors of the congestion.

Traffic congestion is expressed by traffic flow rate (q) and average speed of traffic flow (v), and it is important to understand the status of these factors.

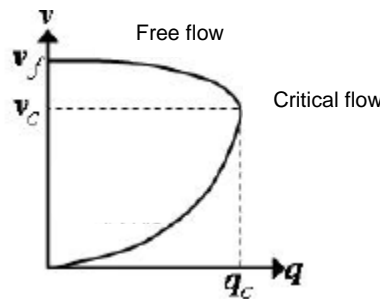

Figure 3.6-1 Relation between traffic flow ratio (q) and average speed (v)

(1) Sensing Technology for Measuring Average Speed of Traffic Flow (v)

A variety of sensors have been developed and put to use for the purpose of measuring the average speed of traffic flow. The representative types of such sensors are shown as follows:

Table 3.6-1 Average speed sensing technology

Technology	Ultrasonic wave sensor	Image processing	Optical beacon
Outline	- Sensor set downward from gantry, or sideways from roadside	- Read license plates for travel time between two points	- From travel time between two points (by acquiring ID with optical beacon)
Disadvantage	- Machinery malfunction and maintenance	- Low accuracy in night-time and bad weather	- Necessity for OBUs to be accommodated
Remarks	- Widely used in EU and US	- Widely used in Japan	- Widely used in Japan

*In addition to the above, a technology for measuring the average speed of traffic flow by using a probe car data is also available (provided that, if probe car data are not widely used, the frequency of such measurement may be low).

(2) Sensing Technology for Measuring Traffic Flow Rate (q)

Techniques for measuring traffic flow rate are roughly outlined as follows:

Table 3.6-2 Traffic flow ratio sensing technology

Technology	Loop coil	Ultrasonic wave sensor	Image processing
Outline	- Embedded coils in road surface to detect moving metal	- Sensor set downward from gantry, or sideways from roadside	- Recognize movement and number of vehicles by image
Disadvantage	- Machinery malfunction and maintenance	- Machinery malfunction and maintenance - High cost due to gantry and sensor in each lane - Not being able to detect vehicles out of lanes	- Low accuracy in night-time and bad weather
Remarks		- Widely used in EU and US	- Multiple lanes can be measured at the same time. - There is no restriction of installing over the lanes

A sensing technology using a space-time Markov Random Field (MRF) model is taken up as an example of image sensors. A space-time MRF model is a technology that performs sensing by putting a regional division in place in a block of eight pixels by eight pixels as one unit and by defining a correlation in the time axis direction that refers to the motion vector per each block between image frames. By using this technology, it is possible to obtain a variety of traffic statistics, including traffic flow rate (q) and average speed of traffic flow (v) without being affected by changes in lighting intensity and the shadow of buildings, among other things.

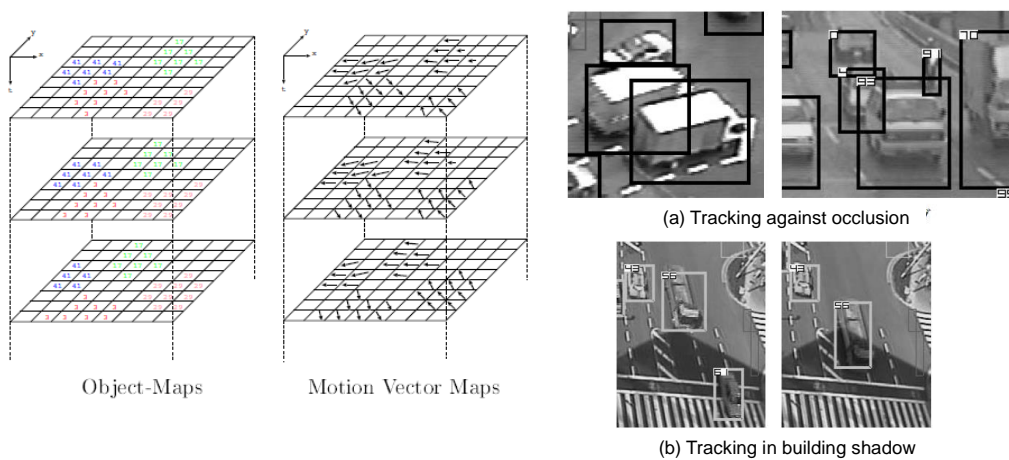

Figure 3.6-2 Conceptual diagram of time-space MRF model and an example of sensing

4. Applications

4.1 Traffic Control

4.1.1 Content of Application

On urban and inter-city expressways, the occurrence of events such as traffic congestion, traffic accidents, abnormal weather and disasters poses a problem in ensuring the safety of road users and smooth traffic flow.

The purpose of a traffic control system is to ensure the safety of road users and smooth traffic flow. This is done by collecting information concerning a variety of events that occur on roads and the resultant road conditions, traffic conditions and weather conditions – and then processing and providing such information to road users in a prompt and proper manner.

4.1.2 Configuration of Traffic Control System

A traffic control system largely consists of (i) information collection infrastructure, (ii) information-processing infrastructure, (iii) information provision infrastructure, (iv) communications infrastructure, and (v) monitoring infrastructure. In addition to the above infrastructures, disaster prevention infrastructure may be included if there are structures that need to be monitored, such as tunnels.

(i) Information Collection Systems

The information collection infrastructure collects information on traffic conditions, weather conditions, etc. As for the method of collecting information on traffic conditions, a vehicle detector is employed in many cases for collecting information on traffic volume, speed, and occupancy levels. The following infrastructure have come to be used more often in recent years: probe cars capable of continuously collecting information on traffic conditions, imaging sensors capable of detecting unexpected incidents (such as sudden deceleration, traffic accident and falling objects), and license plate readers capable of directly measuring required travel times. As a side note, the method for collecting information on required travel times by utilizing EFC's information on time when a vehicle passes through a tollgate has been put to practical use in Japan.

In addition, it is recommended to install weather sensors such as rain gauges to cope with the spate of recent "guerrilla rainstorms" (localized torrential rains), and flood meters in locations that tends to be submerged by floods, such as underpasses.

It is possible to promptly obtain information on disabled vehicles or falling objects on roads by installing emergency telephones and CCTV monitors at regular intervals along roads.

Furthermore, in order to optimally control the entire road network, it is recommended to collect information on adjacent expressways and ordinary roads that run parallel to expressways, from other road managers.

(ii) Information-processing Systems

The information-processing infrastructure processes a vast amount of information provided by the information collection infrastructure, evaluates the levels of traffic congestion, prioritizes information that needs to be provided to the information provision infrastructure, and processes the content of information to be provided.

In recent years, systems have been developed to provide road users with information on projected traffic conditions by analyzing real-time traffic conditions and past trend data. On the metropolitan expressways in Japan, a road information board displays not only information on traffic congestion (such as traffic-congested zones and length of traffic congestion) but also information on trends in changes in traffic congestion.

(iii) Information Provision Systems

The information provision infrastructure provides information processed by the information-processing infrastructure to road users.

Road information boards and highway radio applications are commonly used as the information provision infrastructure. A road information board provides more specific information, such as information on areas where there is traffic congestion or traffic is regulated and the length of traffic congestion. If there are wide-area detour routes available to avoid traffic congestion, it is recommended that a graphic road information board be installed to provide road users with information that enables them to visually understand traffic conditions and available alternative routes and decide on optimal routes which suit them.

Currently, information for personal computer (PC) compatible or Internet-compatible mobile phones and smartphones is also provided to road users via the Internet. In addition, it is possible to provide more detailed information to road users by installing a large display road information board or an interactive road information kiosk in expressway rest areas, which is a computer terminal that provides road information to road users.

In Japan, road-to-vehicle communication systems such as IVI or ITS Spot are utilized as a means of providing information to road users while they are driving. This information includes wide-area roads and comparisons on the number of available routes, amongst other information. It is recommended this information be provided to road users to assist in their effective use of road networks.

(iv) Communications Systems

The communications infrastructure connects the information collection infrastructure and the information provision infrastructure, both of which are installed roadside, to the information-processing infrastructure, which is installed at a road manager's traffic control center or similar.

In Japan, such a connection is often made via wire communication (optical fiber or exclusive line). In recent years, optical fibers have been more extensively used because they are superior in terms of communication capacity and scalability.

In cases where roads are newly constructed, it is more efficient to install the communications infrastructure concurrently.

If it is difficult to newly install a wired communication network for costs and other reasons, it is possible to use an Internet connection as a virtual private network (VPN) connection or use radio communication networks, provided that, as such methods are inferior to an exclusive wired communication line in terms of reliability, it is necessary to fully compare and review all the available methods.

(v) Monitoring Systems

The monitoring infrastructure displays and monitors a variety of information, such as road traffic conditions collected by the information collection infrastructure, the results of information processing conducted by the information-processing infrastructure and the status of information provision.

In many cases, the monitoring infrastructure consists of a large monitor display unit and an operation console. In recent years, the method of displaying a simplified route map showing road routes under control and their traffic conditions in a monitor display unit in an easy-to-understand manner has become a favoured method.

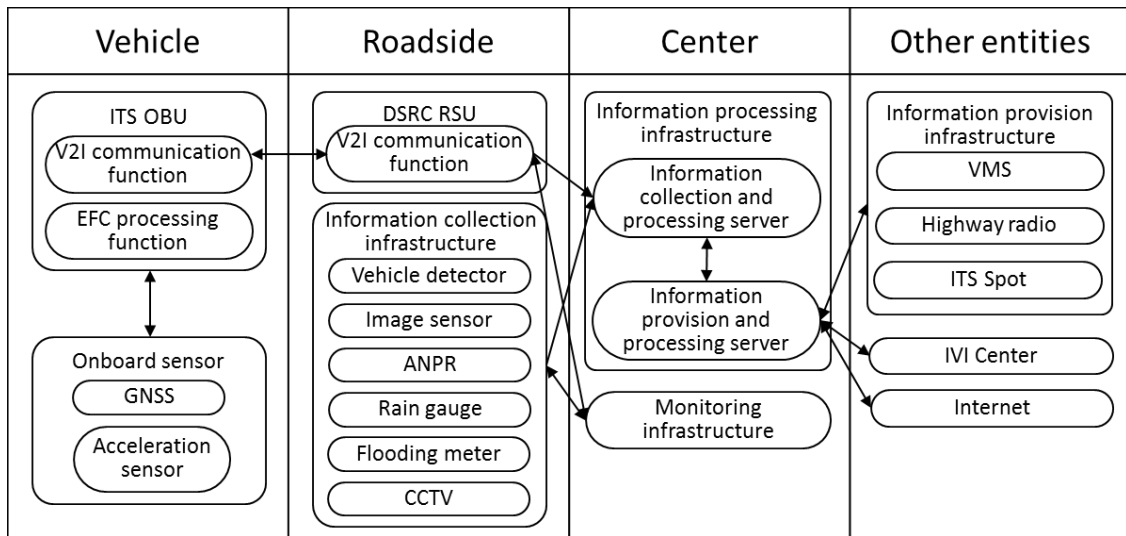

Figure 4.1-1 System configuration flow

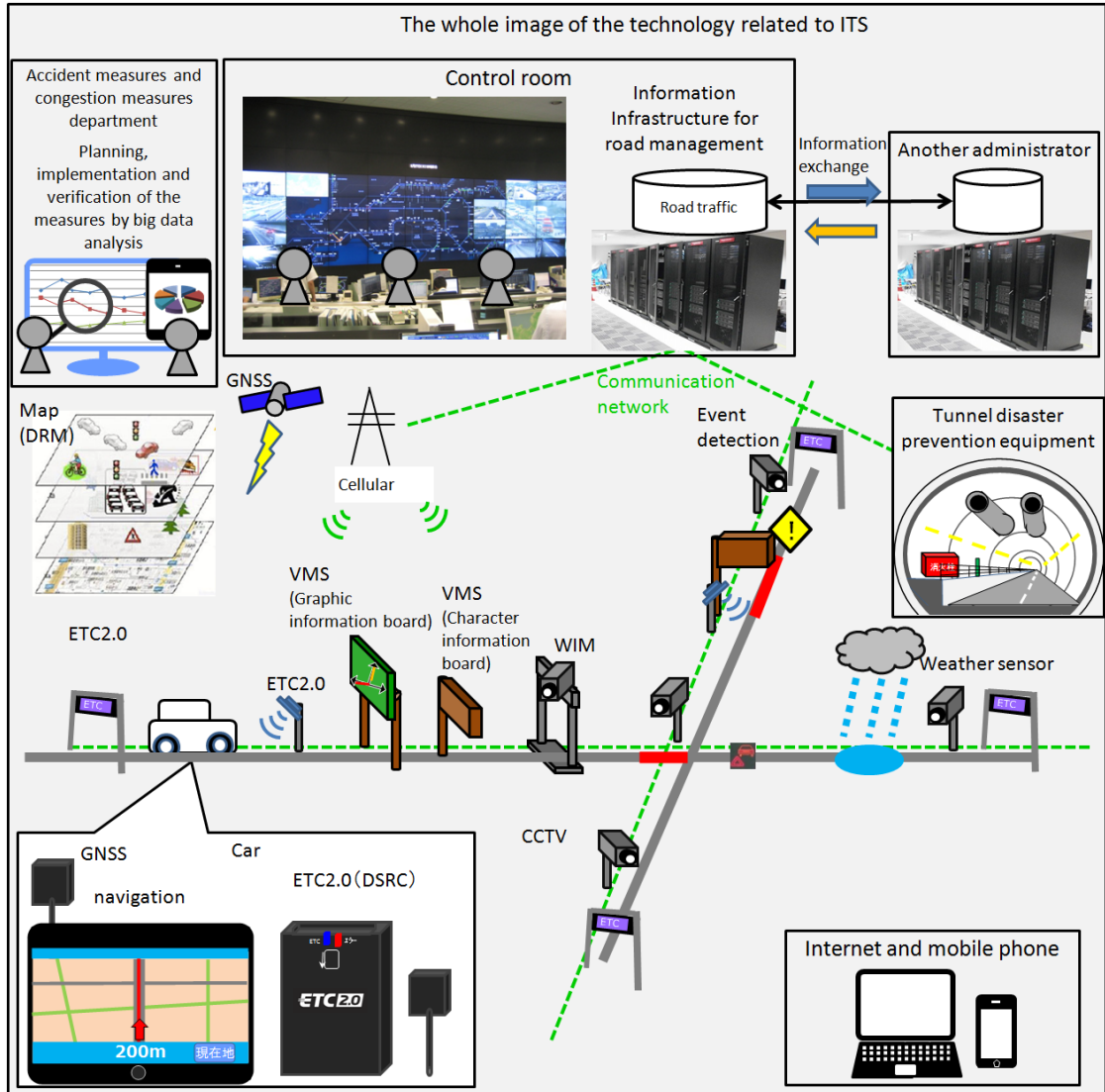

Figure 4.1-2 The whole image of the technology related to ITS

[Reference] Example of Traffic Control System

Expressway companies are monitoring the traffic situation of expressways for safe, secure, and comfortable driving and are evaluating a variety of equipment necessary for traffic control 24 hours a day. Figure 4.1-3 shows the example of traffic control center of Central Nippon Expressway Company Limited.



Figure 4.1-3 An example of traffic control center
(Source: Central Nippon Expressway Company Limited)

[Reference] Active Traffic Management (ATM) in the UK

Chronic traffic congestion to the tune of 120,000-plus cars occurs every day on the M42 near Birmingham in the UK. Active Traffic Management (ATM) was introduced on road sections of 17km in 2006 in an attempt to combat this problem.

ATM aims at alleviating traffic and improving safety by actively managing traffic. It does this by using information technology such as changing regulatory speeds and opening berms to general drivers according to traffic.

In a normal traffic situation, if nothing is displayed on the variable information sign, the speed is limited to 70 mph (approximately 110 km/h) and berms are available only in the case of emergency.

When the system confirms congestion, the vehicle detection loop and CCTV in the control room informs drivers of countermeasures on the variable information board. First, "congestion alert" and "accident alert" are displayed. Then the speed limit and lane closure are displayed.

As congestion and accidents increase traffic, berms are used for general traffic. When the closure information on the variable information board disappears, the speed limit is displayed for drivers.

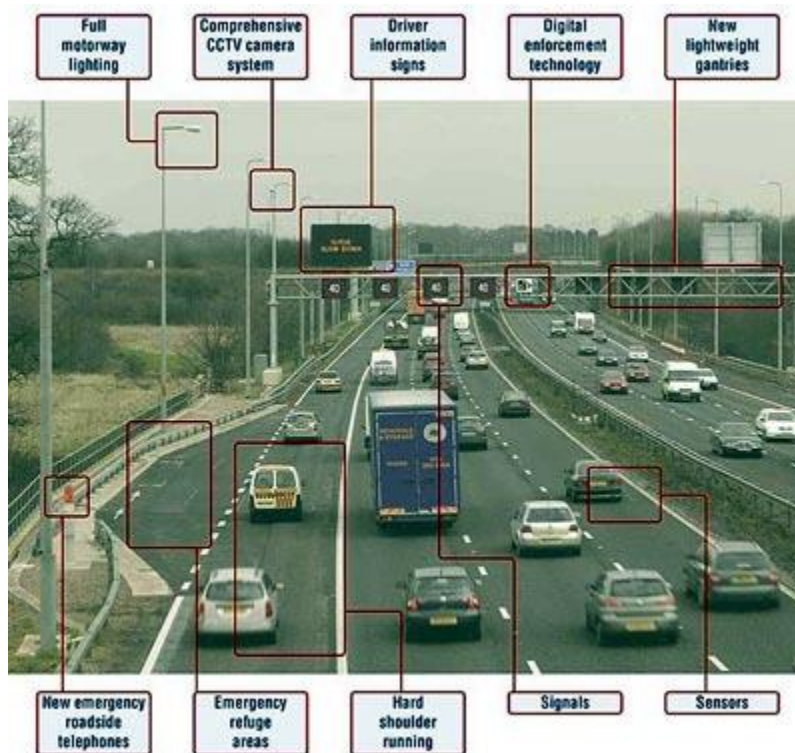

Image courtesy of: Highways Agency

Figure 4.1-4 Active Traffic Management (ATM) on M42

4.2 Traffic Signal Control

4.2.1 Content of Application

In large city areas where traffic congestion has become very serious, it is possible to increase the efficiency of traffic flow by adopting more sophisticated signal control systems to help alleviate traffic congestion.

For methods of traffic signal control, a coordinated signal control system is commonly used. This system defines main roads as primary roads and roads that intersect with primary roads as subordinate roads; traffic on primary roads is then controlled on a priority basis. Studies are currently underway on a network signal control system which aims to optimize traffic flow across the entire road network through the further sophistication of coordinated signal control.

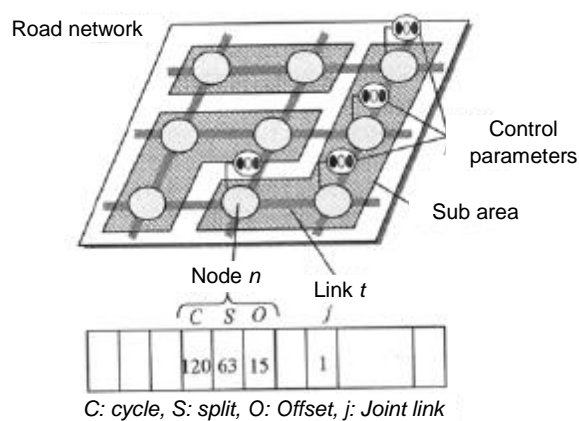

Figure 4.2-1 Conceptual diagram of network control

(Source: S. Kamijo, Sensing technology for making traffic efficient)

It is also possible to perform more sophisticated signal control functions by using real time traffic data such as traffic volume, occupancy rate and queue length (see the next page).

A vehicle detector, which is installed on the upstream section of a traffic signal, is commonly used to collect information on traffic volume, occupancy rate, etc.

Table 4.2-1 Classification of Traffic Signal Control by Generation and Key Input Data

Generation	Designed control contents	Control design	Control	Systems abroad
1	Traffic volume	Designed off-line	Fixed time control	
1.5	Traffic volume/ Occupancy	Designed off-line, but use data of detectors	Pattern selection with unit time data	SCATS (split, offset)
2	Traffic volume/ occupancy/ vehicles in queue/ degree of saturation	Online generated	Compute per time unit with time unit data	SCATS (cycle) SCOOT (cycle)
2.5	All of the above, and estimated time of arrival (detector -> stop line)	Online generated	Calculate estimated delay per second (cycle/ signal indication)	SCATS (split, offset) MOVA (isolated intersection)
3	All of the above, and forecasted time of arrival	Online generated	Calculate forecasted delay of 1 – 2 minutes ahead per 3 – 5 minutes	OPAC (US) PRODYN (France) UTOPIA (Italy)

Source: Japan Society of Traffic Engineers, Revision of manual for traffic signal

4.2.2 System Configuration

In order to further advance traffic signal control and obtain a more detailed understanding of the traffic data, the following methods can be utilized (in addition to an existing vehicle detector): (i) installation of new sensors at intersections (utilization of imaging sensors, etc., for the collection of data, such as inflow traffic volume, outflow traffic volume and bifurcating traffic volume by direction) and (ii) utilization of probe car data for the collection of data on vehicle speed and queue length.

Through the installation of new sensors at intersections by utilizing probe car data, traffic signal control could be sophisticated. By assuming inflow traffic volume and queue length as the amount of vehicular traffic demand, it is possible to determine the cycle length that is required to cope with such vehicular traffic demand and the distribution of traffic signal splits. It is also possible to determine optimal offsets between intersections based on vehicle speed data obtained from probe car data.

In order to enhance the reliability (real-timeliness) of data on vehicle speed and queue length from probe car data, it is necessary to secure a sufficient number of vehicles fitted with probe devices.

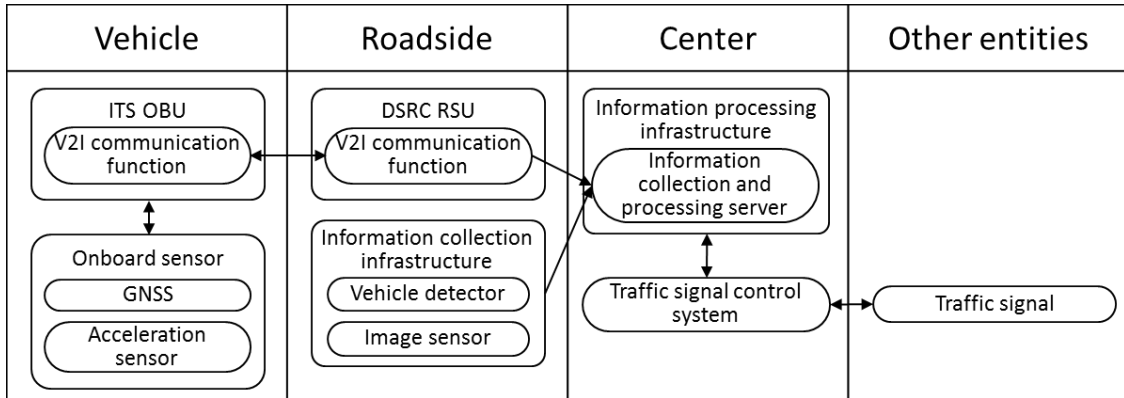
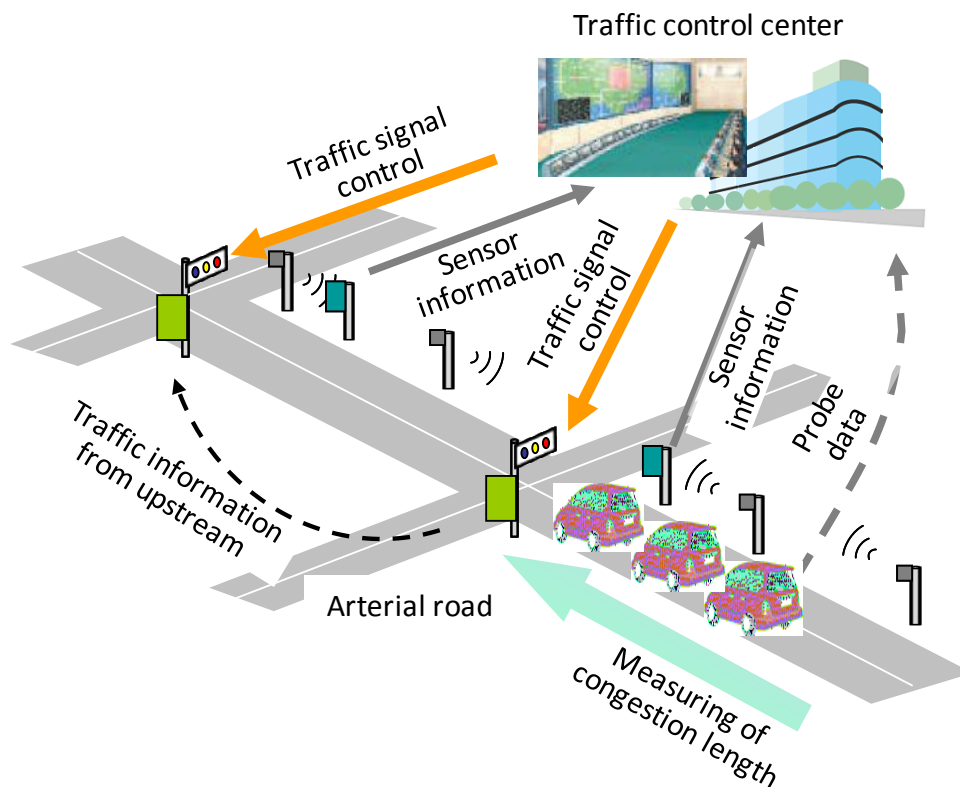

Figure 4.2-2 System configuration flow

[Reference] Example of Traffic Signal Control and Traffic Control Systems in Japan

In Japan, a traffic control system that is capable of controlling all traffic conditions from under-saturation to over-saturation has been realized by implementing either macro or micro control, or both macro and micro controls in combination, depending on traffic conditions.

In Japan, signal control is performed by using sensors that are installed roadside at close intervals. In countries or cities where the number of existing roadside sensors is small, it is possible to realize more sophisticated signal control by introducing probe car data that is capable of measuring both the length of traffic congestion and vehicle speed as well as utilizing data obtained from probe car data for signal control.



● **Macro control**

“**MODERATO**”

- Japanese unique method of measuring congestion length
- Execute suitable control continuously based on congestion length in addition to traffic volume

● **Micro control** “**Profile traffic signal control**” changed from “**Sensitive control**”

- Control traffic signal finely based on the traffic volume of the upstream
- Correspond to rapid change in traffic volume
- Function individually without traffic control center

Figure 4.2-3 Image of the system using Japanese style traffic signal control and traffic control

[Reference] Representative Traffic Signal Control Technologies

A variety of traffic signal control systems have been developed in many countries of the world. The three most well-known traffic signal control systems in the world are Australia's Sydney Coordinated Adaptive Traffic Systems (SCATS), the United Kingdom's Split Cycle Offset Optimization Technique (SCOOT), and Japan's Management by Origin-Destination Related Adaptation for Traffic Optimization (MODERATO).

(1) SCATS

In SCATS, the basics of signal control are the optimization of splits at a single intersection. The degree of saturation (DS) is used as a parameter, and splits are controlled according to the rate of DS of intersecting traffic flows. In SCATS, loop detectors are installed in front of the stop line of an intersection, and DS values are calculated based on the ratio of ON-OFF time of these loop detectors. In the following figures, thick lines represent the ON state, in which a loop detector detects a vehicle.

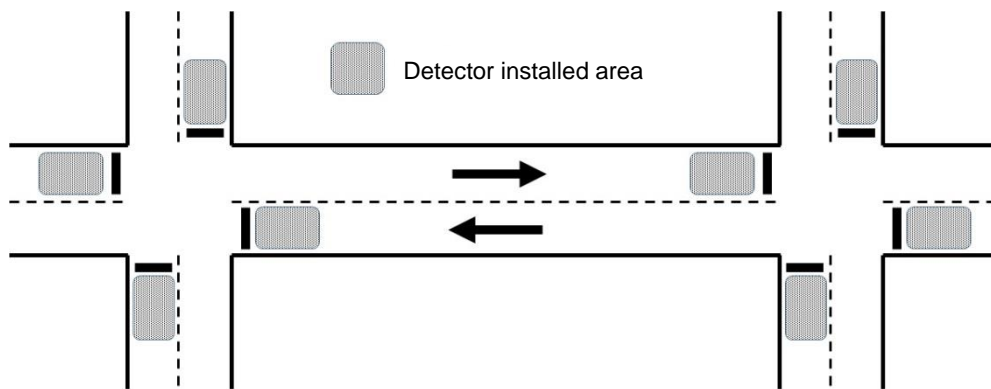

(a) Detector installation in SCATS

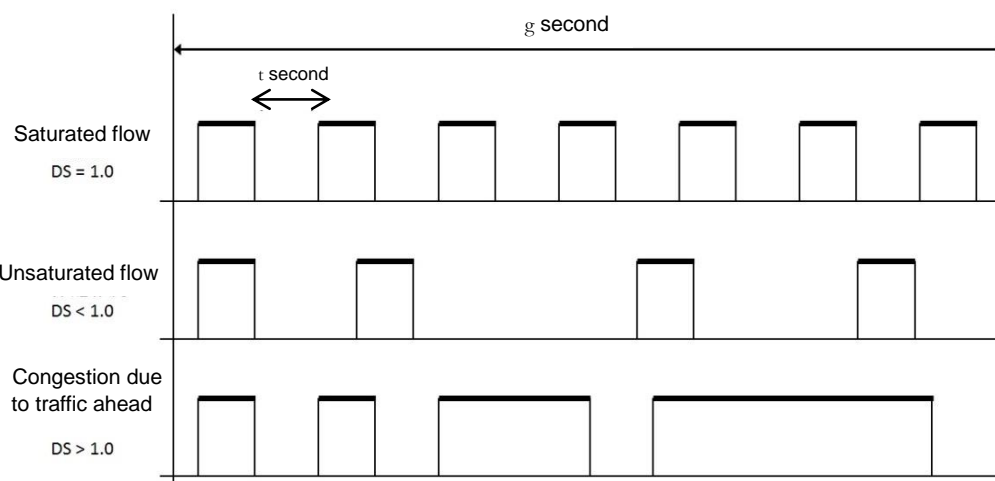

(b) Concept of Loop Detection

Figure 4.2-4 Traffic Flow Measurement Method in SCATS

Broadly speaking, the time when a loop detector is ON is short when traffic is light, while it is long when a vehicle queue is generated by traffic congestion.

The number of passing vehicles and the inter-vehicle time are measured immediately before the stop line. This will not only directly measure the level of congestion at an intersection but also facilitate system control by consolidating measuring sensors near an intersection. SCATS has been adopted in many countries in Asia because of its simplicity. Loop detectors are commonly used for SCATS but their main disadvantage is the high cost of installation and repair. Going forward, it is important to try to reduce the cost of installation and repair by adopting imaging sensors, etc.

(2) SCOOT

SCOOT's main characteristic works by optimizing offsets by predicting vehicle arrival profiles. For this reason, in the case of SCOOT, it is desirable to install detectors upstream from the average queue length at a traffic light. In fact, in many cases, detectors are installed on the upstream side and at locations about 20 meters from the exit of an intersection.

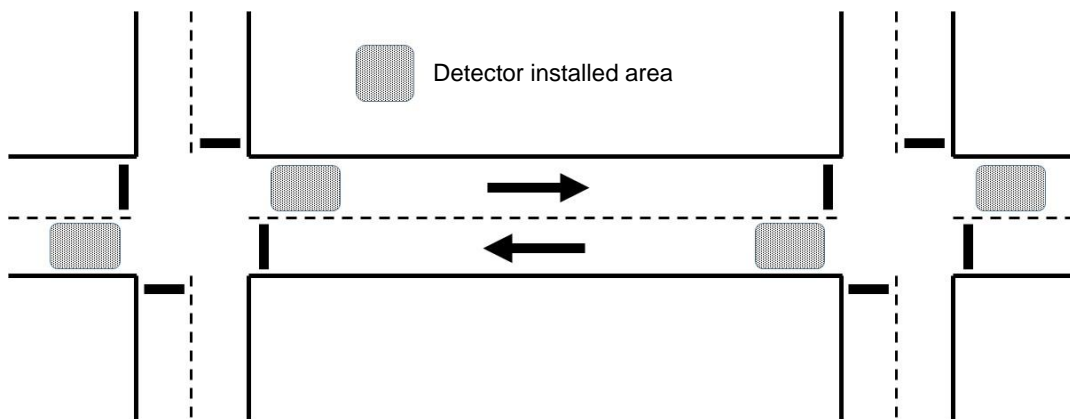

Figure 4.2-5 Detector installation in SCOOT

(3) MODERATO

MODERATO, an index that utilizes the number of vehicles queued at an intersection, is used as DS. This is in addition to the inflow traffic volume into an intersection as used in SCOOT. As there is heavy traffic congestion in Japan, DS is weighted by the demand of vehicles in queue at an intersection. It is not unusual in Japan for the length of traffic congestion to extend past one kilometre. Because of this, sensors are installed for more than one kilometre at an interval of several hundred meters from a critical intersection where traffic congestion is heavy.

SCATS, which is designed primarily for traffic signal control for a single intersection, is designed to control offsets by selecting patterns according to traffic volume. Thus, it looks like offsets are controlled on an after-the-fact basis. In contrast, SCOOT is a strategy that is intended to allow arriving vehicles to pass through an intersection in the most efficient manner by preparing vehicle arrival profiles, and it forms the basis of today's coordinated signal control systems. In MODERATO, which is based on SCATS, the length of congestion is factored into DS with the aim of reducing lengthy and heavy traffic congestion that originates from congestion at a critical intersection where main roads cross each other.

4.3 Electronic Fee and Toll Collection (EFC) System

4.3.1 Toll System

There are two methods of Electronic Fee Collections (EFC): DSRC and autonomous methods. DSRC charges tolls using vehicle to infrastructure communications between roadside antennas and onboard units. Autonomous method charge tolls by onboard unit by acquire its own location based on information through Global Navigation Satellite System (GNSS).

DSRC method has advantages of high accuracy, making fraud difficult, as well as not requiring communication costs. However, it requires furnishing facility at every location for tolling, and thus, it is not suitable for having numerous tolling points or for toll roads that often change tolled sections.

Autonomous toll method has advantages of changing setting flexibly such as distant based toll. However, it would require roadside facility to regulate and control fraud. It also requires high communication costs.

4.3.2 Service Contents

EFC with DSRC is a system designed to manage the entry of vehicles to a toll road as well as processing the payment of tolls by utilizing radio communications between the EFC onboard unit of passing vehicles and a roadside system. EFC users can enter a toll road without having to stop at a toll gate. With the use of EFC, it is also possible to offer EFC users a mileage bonus program that is based on the amount of tolls paid (reward points are given to EFC users for the amount of tolls paid and when a certain level of reward points is accumulated, they can be used to pay a part of tolls.)

In addition, it is expected that the use of the EFC toll payment processing system using DSRC will be expanded to serve as a multipurpose payment processing system, such as for processing payments at parking facilities and gasoline stations. DSRC, which is suitable for use for free-flow systems (payment of tolls using radio communication devices installed alongside a toll road), is capable of coping with a wide variety of charging methods.



Figure 4.3-1 Image of EFC system

Table 4.3-1 Contents of each application

Application	Contents
Payment process	<ul style="list-style-type: none"> - Automatically collect tolls based on travel distance or flat rate system at barriers of toll road - Correspond to discount process such as time-based discount
Mileage	<ul style="list-style-type: none"> - Issue points based on the fee - Toll can be discounted depending on the accumulated points

4.3.3 System Configuration

DSRC EFC consists of roadside antennas, roadside units, in-vehicle onboard unit, and Integrated Circuit (IC) cards.

Information about the tolls is exchanged at the entrance or exit of a toll road via two-way radio communications between vehicles and roads using active DSRC in the 5.8 GHz band, and tolls are charged according to the distance traveled. Depending on its system configuration, EFC is also capable of being flexible, coping with a variety of toll collection methods, such as distance-based pricing, flat rate pricing, time-based discount pricing, and long distance travel discount pricing.

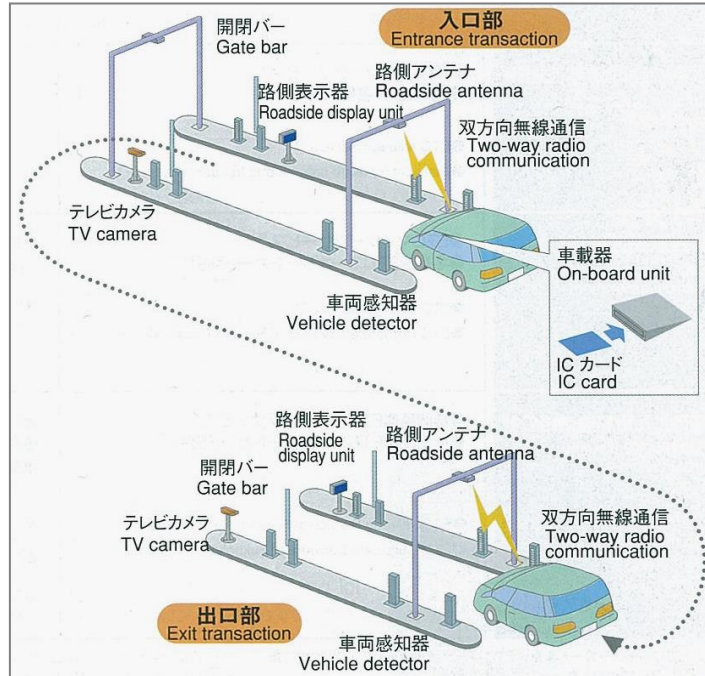

Figure 4.3-2 Mechanism of DSRC EFC (Source: ITS Handbook)

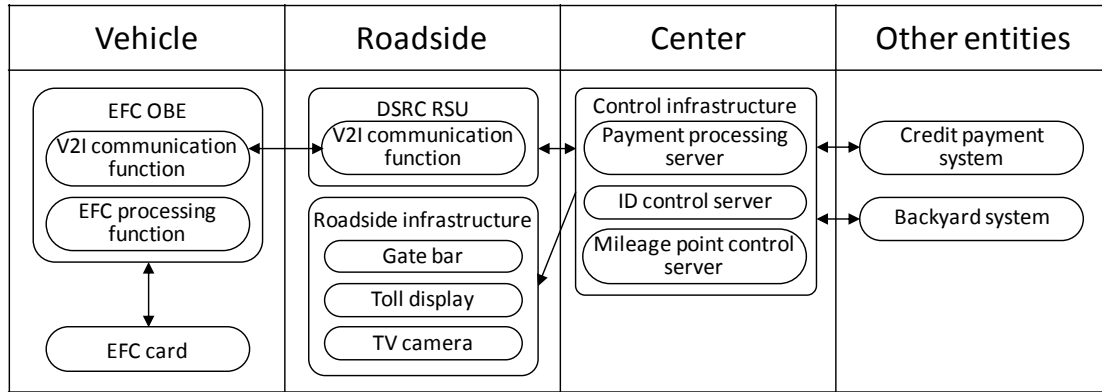

Figure 4.3-3 System configuration flow

In the case of EFC, a Radio Frequency Identification (RFID) tag system is made available in addition to an active system and a passive system. The comparison of different EFC systems is shown in the table below. It is recommended that, as there are advantages and disadvantages in each of these EFC systems, the adoption of an EFC system be studied carefully, taking future scalability into consideration.

4.3.4 Expanded services

The autonomous EFC serves to charge tolls on motorists but it is also used as a platform for a wide range of ITS services thanks to the sophisticated functions embedded in onboard devices, including seamless self-positioning, communication with the centre system and driver interface.

Examples of these services are provided below. An autonomous EFC is generally superior to a smartphone in position orientation accuracy and device reliability with the ability to solve regional road traffic problems and wide commercial applicability.

(1) Traffic Management

Meticulous traffic information (vehicle position, speed, origin and destination, etc.) is compiled from onboard devices and analyzed to formulate, regulate and guide road planning.

(2) Travel/Traffic Information

Traffic and congestion information is relayed to the driver and optimal routes that avoid jams are provided.

(3) Public Transport Information

Bus operation conditions are assessed and communicated to users and controls such as departure increases and route changes.

(4) Taxi Dispatch

A taxi dispatch system utilizing onboard devices and communication infrastructure to facilitate dialogue between users, taxi managers and drivers.

(5) Fleet Management

Truck and other commercial vehicle operation conditions are assessed to facilitate scheduling.

[Reference] The Image of the Processing of the Payment of Tolls on Toll Roads (where tolls vary according to the distance travelled)

- The comparison of the processing of the payment of tolls by onboard unit and the Centre (using a read-only RFID system, etc.) is shown below. If tolls are processed by the Centre, there is a heavier burden on the Centre. This means the Centre must be highly reliable, as all relevant data collected both at the entrance and exit of a toll road must be sent to there and then consolidated by the Centre itself. In addition, the relevant communication network must be highly reliable as there is an exchange of data between the Centre and roadside infrastructures.
- Alternatively, if tolls are processed by onboard unit, there is less of a burden on the Centre. With the charging and payment of tolls processed by onboard unit and a roadside unit, the Centre is only processing the settlement of tolls with card issuers.

1) When Payment of Tolls Is Processed by Onboard unit

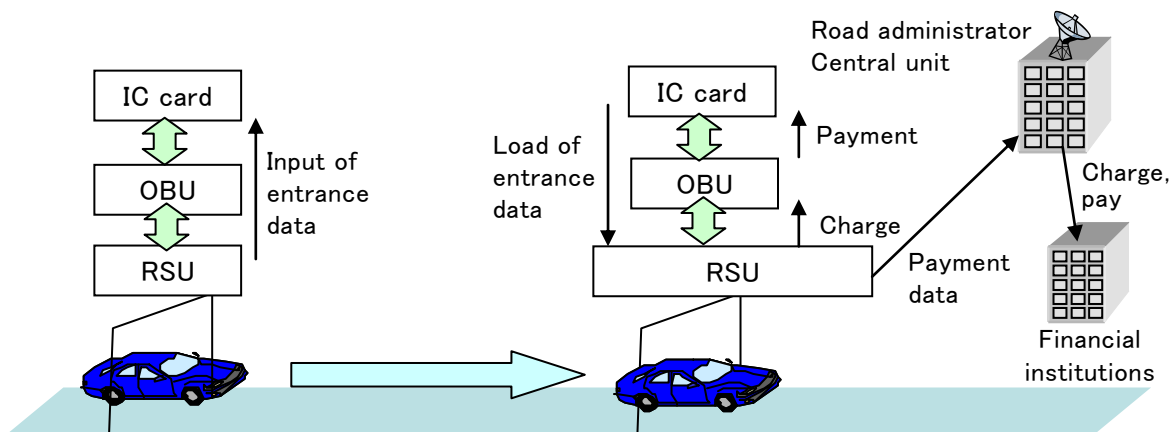

Figure 4.3-4 Image of payment processing with OBU

2) When Payment of Tolls Are Processed by the Center (using RFID system)

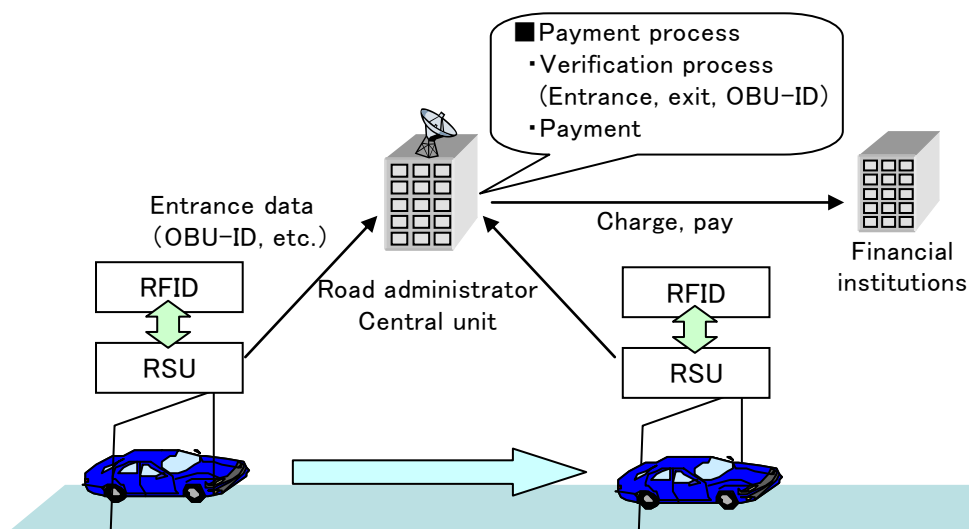

Figure 4.3-5 Image of payment processing at the Center

[Reference] Examples of utilization of EFC Systems (utilization of EFC systems as smart IC systems, etc.)

As it is possible to simplify a toll gate structure and eliminate toll collectors by utilizing DSRC EFC systems, it is therefore possible to establish toll road interchange or entrance/exit facilities at lower costs in a more flexible manner than those previously installed.

The installation of smart IC systems has already progressed in Japan and produced positive results. It has alleviated traffic congestion, reduced travel time on ordinary roads, revitalized local economies and reduced the response time of emergency vehicles.

■ Example of smart IC



Figure 4.3-6 Example of smart IC (Miyoshi smart IC in Kanetsu Expressway) (Source: MLIT)

■ Example of Toll Road Exit for Ambulances



Figure 4.3-7 Example of Toll Road Exit for Ambulances

[Reference] ERP (Electronic Road Pricing)

Singapore has a road pricing system in place that controls traffic flow through its extremely congested Central Business District (CBD) by charging any vehicle that ventures in. In 1975, it adopted a manual road pricing system where police officers visually verified stickers affixed to vehicle windshields - but they quickly realized that purchasing those stickers was burdensome and surveillance costs were high. Planners ended up looking for a more flexible means of controlling traffic. The introduction of a new electronic fully automated ERP system resolved these issues.



Figure 4.3-8 Road Pricing prior to ERP Introduction



Figure 4.3-9 ERP Overview

Because ERP is a completely electronic multi-lane free flow system, overall costs are low and there is no need for acceleration and slowing down at tolling areas making it both environmentally and user friendly. A focus on the development of applications other than road pricing at the onset of system conceptualization led to the adoption of a two-piece on-board device in which a prepaid IC card is inserted. The system is completely unmanned with cameras installed on gantries photographing any vehicle without an ERP device mounted on-board. Any driver who may have forgotten to prepay their cards is sent a bill demanding the payment of a penalty fee automatically. Not long after ERP's inception, data showed a decline in traffic of approximately 20%.

As mentioned in item 3.4.3, the characteristics of ERP has realized services above and beyond mere road pricing, that are both flexible and varied to an extent not experienced anywhere else in the world.

ERP is composed of antennas, vehicle detectors, surveillance cameras and lights mounted atop gantries, devices installed in vehicles, IC cards and central computers. Tolls are determined by gantry location, day of the week, time of day, and type of vehicle. Displays mounted on the gantry show the toll amount, which can be visually checked by the driver when passing through. The on-board devices and antennas passively communicate in the 2.45 GHz band. Another feature is that almost all vehicles in Singapore are equipped with ERP devices.

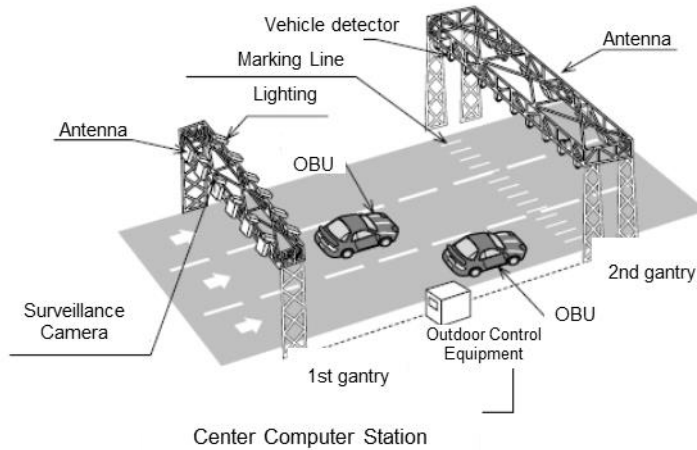

Figure 4.3-10 Overview of ERP System Equipment

Table 4.3-2 ERP Onboard Unit Standards

Radio frequency	2.45GHz
Radio system	Passive system (homodyne detection)
Throughput	Down : 56kbps Up : 124kbps
Card standards	ISO7816 ISO14443 Type B*
Temperature	0°C - + 85°C

*Card standards for Second generation OBU using Contactless IC card system

[Reference] Autonomous EFC

Unlike DSRC, Autonomous EFC system, onboard devices acquire their own positions on the road based on signals received from GNSS satellites. Moreover, those devices communicate with centre systems to report positioning and tolling information and update stored data.

A feature of this system is the lack of any significant roadside unit; however, in the interest of fairness, certain equipment is necessary for disciplinary purposes. For example, vehicles on a toll road without a device installed onboard are photographed and charged a penalty fee. Equipment to regulate motorists can be set up independently from tolling locations. For example, roadside infrastructure can be constructed on major roads, whilst in other areas, mobile regulatory systems can be mounted in vehicles to reduce costs, while maintaining maximum effect.

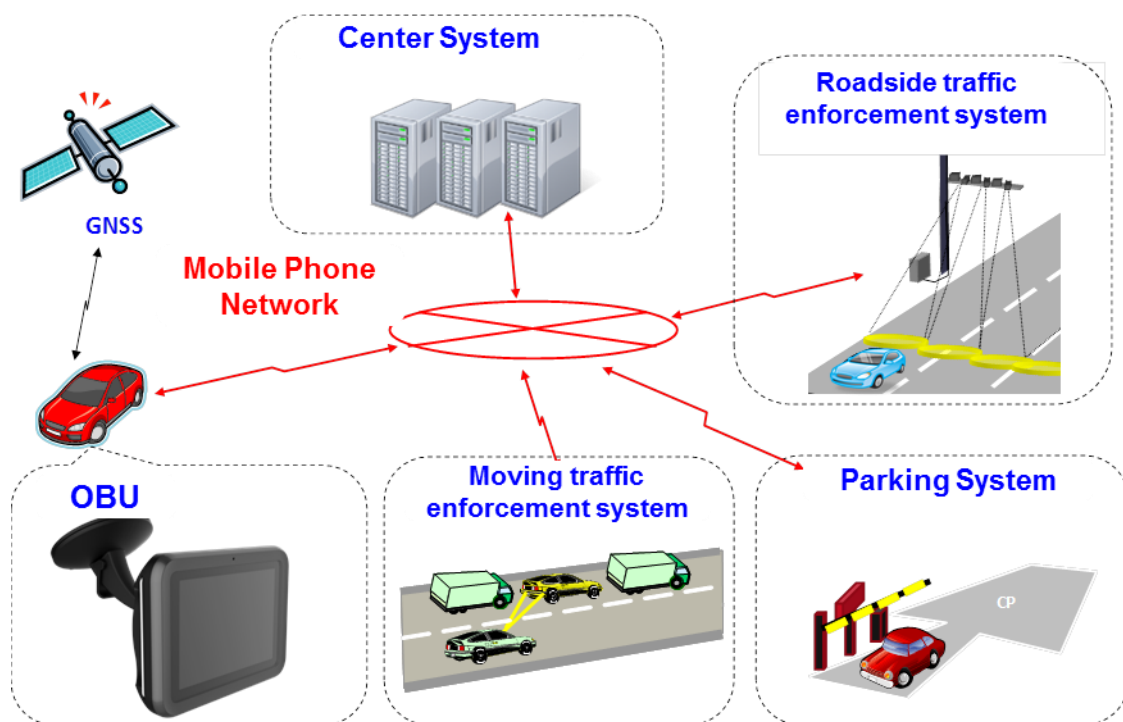

Figure 4.3-11 Standard configuration of an autonomous EFC

(1) Germany and Slovakia's highway heavy vehicle tolling

In Germany, an automated tolling system for heavy vehicles of 12 tons or more operating on the Autobahn was launched in 2005. It was later expanded to impose toll charges on some federal roads, after trucks deviating on alternate routes to avoid tolling created congestion. In the summer of 2015, the system began tolling vehicles weighing 7.5 t or more. By 2018, all federal roads will be subject to tolling. Slovakia's primary national highways and some regular roads began tolling heavy vehicles (3.5 t or more) with an automated system in 2010.

(2) Singapore's next-gen ERP

While its DSRC-type ERP has already been introduced to alleviate downtown congestion, the city and state plans to update it by switching to an automated tolling system. Planners want more accuracy than the autonomous EFC projects being developed in Europe, enabling them better positioning among Singapore's many buildings and tunnels and its particular road structure. They will also add multiple new functions to enhance motorist convenience such as traffic information transmissions and parking fee charging. Launch is scheduled for about 2020.

[Reference] Multi-purpose Payment System e.g. Parking

Multipurpose payment processing applications, such as those used to process payments at parking facilities, consist of the following three applications; processing of payments, controlling the entry and exit of vehicles to a toll road (“entry-exit control”), and provision of facility information.

(1) Processing of Payments

Payment processing applications, such as those for processing payments at hourly parking facilities, are roughly divided into applications provided by the following two systems: a payment processing system using multipurpose IC cards and a payment processing system linked to vehicle numbers.

A payment processing system using multipurpose IC cards enables parking fees to be paid with regular credit cards as pre-registration with the relevant parking facilities is not required. In addition, it enables a wide variety of applications to be provided, such as recording information on discounts and reward points and the usage of cards used for other payment processing applications, amongst other things.

A payment processing system linked to user numbers enables the provision of applications using EFC onboard unit. But it requires pre-registration with the relevant parking facilities or a link to applications for processing the payment of parking fees to EFC onboard unit’s vehicle number.

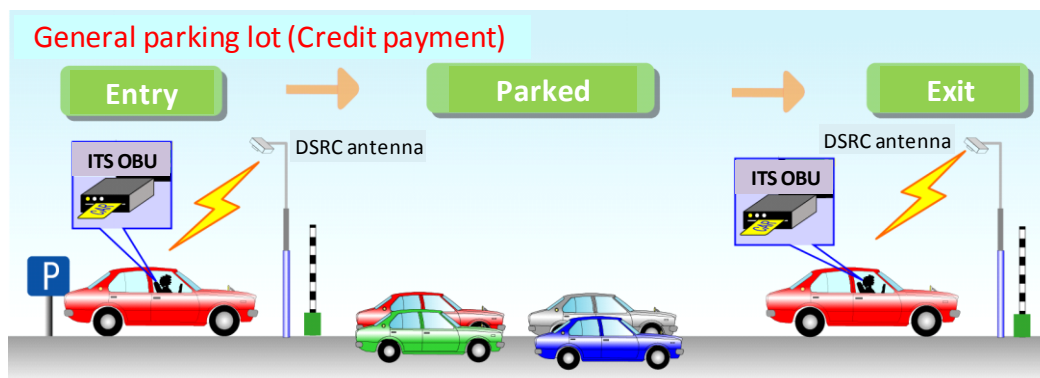

Figure 4.3-12 Image of payment processing application

(2) Entry-Exit Control

An entry-exit control system is divided into the following two types: the one using vehicle numbers and the one using both user numbers and multipurpose IC cards.

An entry-exit control system using user numbers is designed to control the entry and exit of vehicles by reading the vehicle numbers of EFC onboard unit to identify whether vehicles are contracted or not. An entry-exit control system using both vehicle numbers and multipurpose IC cards is designed to control the entry and exit of vehicles by reading vehicle numbers or the ID numbers of multipurpose IC cards to identify whether vehicles or their drivers are contracted or not.

(3) Provision of Facility Information

Information regarding facilities like designated parking spaces for the handicapped, an overview of facilities, the usage of parking facilities, etc., is provided to ITS onboard unit in the form of text, voice commands or still image, via push-type information distribution systems.

[Reference] Examples of Application Introduction

■ Introduction of parking fee settlement systems in Japan

• *Machikado* (Street Corner) e-Applications (Hanshin Expressway Company Limited)

*Payment of parking fees can be automatically processed by using ETC at toll parking facilities.
(Implementation period: May 2008 to August 2014)

• Off-Expressway Parking Applications (Hanshin Expressway Company Limited)

*The applications enable a user to pay the “through toll” by using ETC even when he/she exits an expressway once, uses off-street parking facilities, and then re-enters an expressway again.
(Implementation period: February 2009 - ongoing)

• Times' EFC Applications (Times 24. Co., Ltd.)

*The EFC system can also handle affiliated applications (applications of providing discounts when using affiliated commercial facilities).

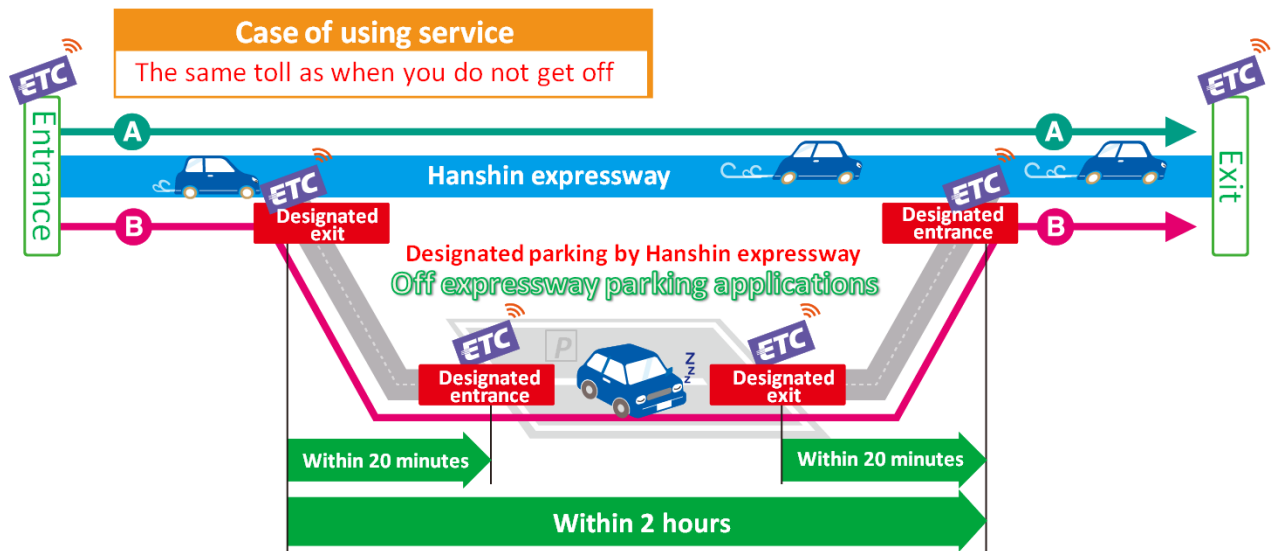

Figure 4.3-13 Example of Off-Expressway Parking Applications

Source: Hanshin Expressway Company Limited

■ Introduction of a parking fee settlement system in Singapore

There are about 3,000 cashless parking lots all over the island constituting the EPS (Electronic Parking System). Driver stress is greatly reduced as there is no need to stop or open and close the window when entering or exiting a lot. Because the gate is managed by the host computer, parking fees can be set at any random time making it a very advantageous system for the parking lot manager.

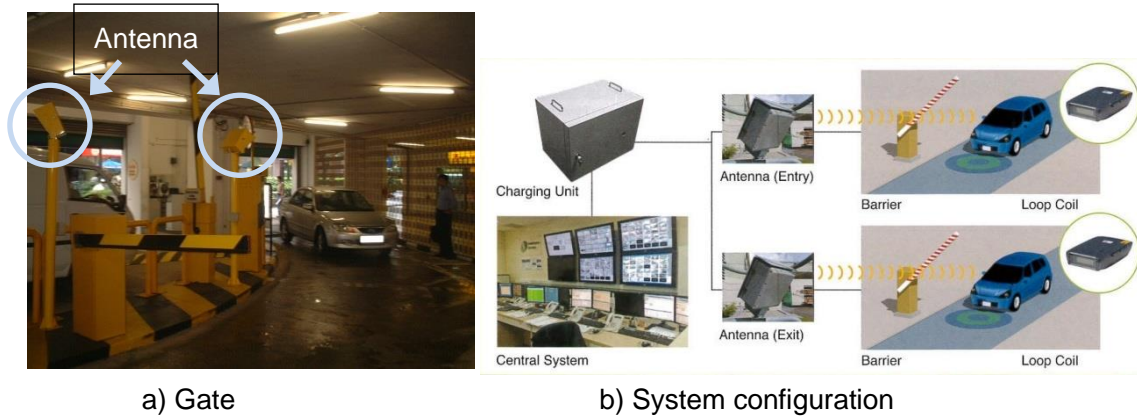

Figure 4.3-14 EPS (Electronic Parking System)

Compatibility with commuter cards began with the advent of 2nd generation onboard devices which had their range of services upgraded in 2009. These can function with contactless IC card systems. Prior to that was the incompatible first-gen onboard devices of the contact-type IC card system.

4.4 Probe car data collection

4.4.1 Contents of application

Probe car data collection is designed to monitor the operations of vehicles by obtaining information on vehicle ID, etc., from passing vehicles via DSRC roadside radio communication equipment.

In the past, the main method for collecting road traffic information was to collect spot data using roadside detectors, and CCTV cameras but the utilization of DSRC or mobile phones for traffic data collection has made it possible to upload probe car data from buses, taxis and ordinary vehicles. A mobile phone is suitable for collecting data from buses and taxis on a real-time basis but the disadvantage of using a mobile phone for this purpose is that a user has to bear the relevant communication costs. On the other hand, DSRC is not suitable for collecting information on a real-time basis, but its advantages is that communication costs are free – and it can share information with EFC, amongst other things.

Probe car systems have made it possible to obtain sequential traffic data and it is expected that the use of probe car data systems will be further expanded to include the provision of a variety of applications, such as traffic control, road management, and bus location systems.

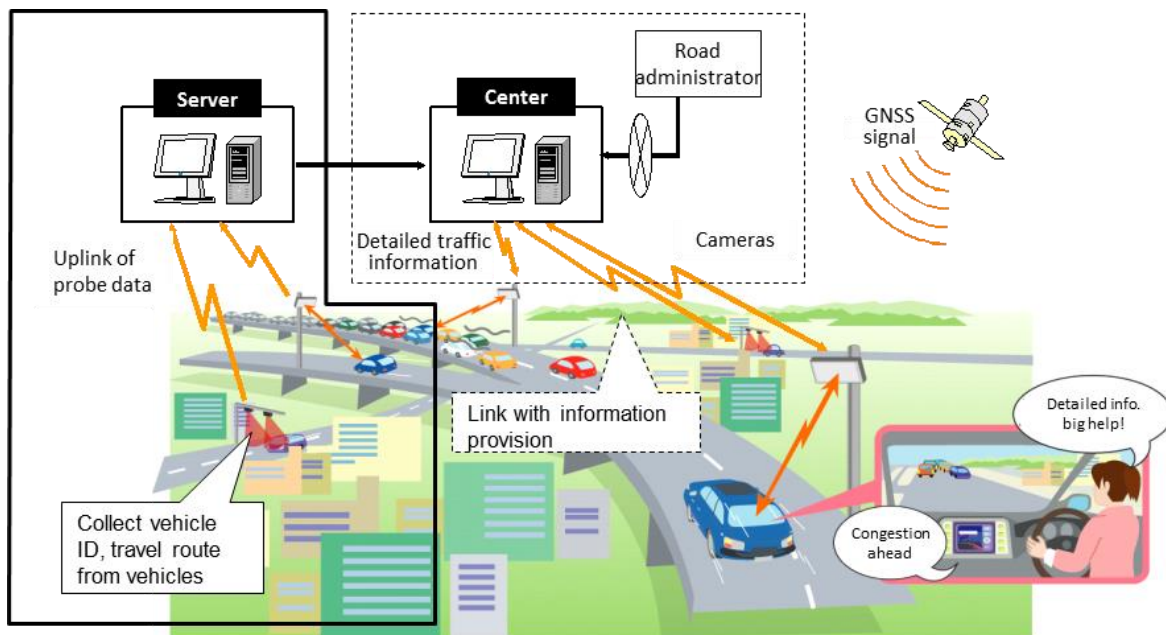

Figure 4.4-1 Image of probe car data collection

Probe car data collection is provided by the five information collection related applications shown in Table 4.4-1. These applications are used for the collection of information on vehicle ID, time and location, weather and vehicle behaviours, amongst other things.

Table 4.4-1 Contents of application

Application	Contents
Collection of vehicle ID	- Vehicle ID
Collection of travel history	- Information on time and location
Collection of detailed travel history	- Information on speed, direction, acceleration, and angular velocity
Collection of vehicle control information	- Information on outside temperature, wiper operation, ABS operation, traction control
Collection of operation information	- Information on vehicle, bus usage, freight vehicle, oversized vehicle, hazardous material vehicle information

4.4.2 System Configuration

The basic system configuration as described below is used for collecting road traffic information using probe car data.

A network for the collection of road traffic information consists of roadside infrastructures and the centre. The following application is used under this network format to provide road traffic information collection applications; an application that collects data from roadside sensors and vehicles sends all the data to the centre for data processing and provides information on road traffic and other conditions as processed by the centre to travelling vehicles.

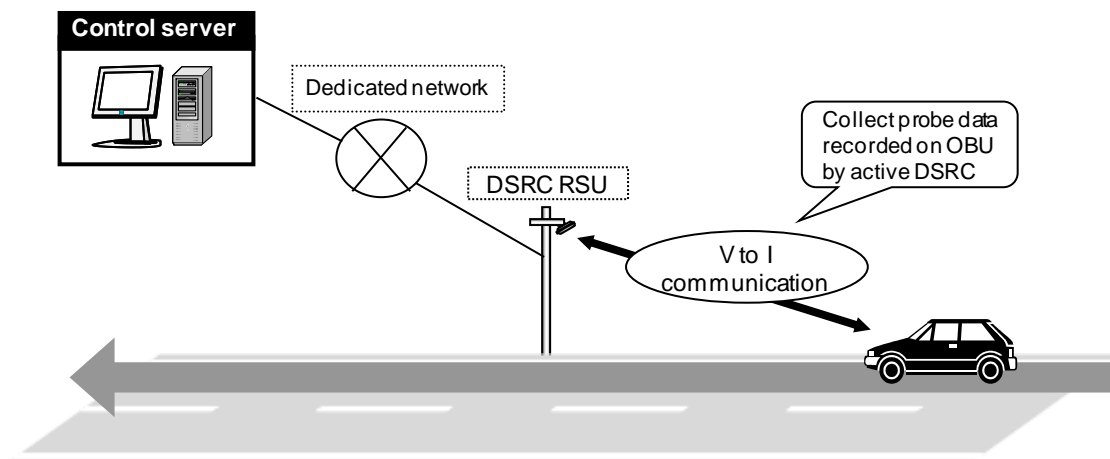

Figure 4.4-2 Image of system configuration

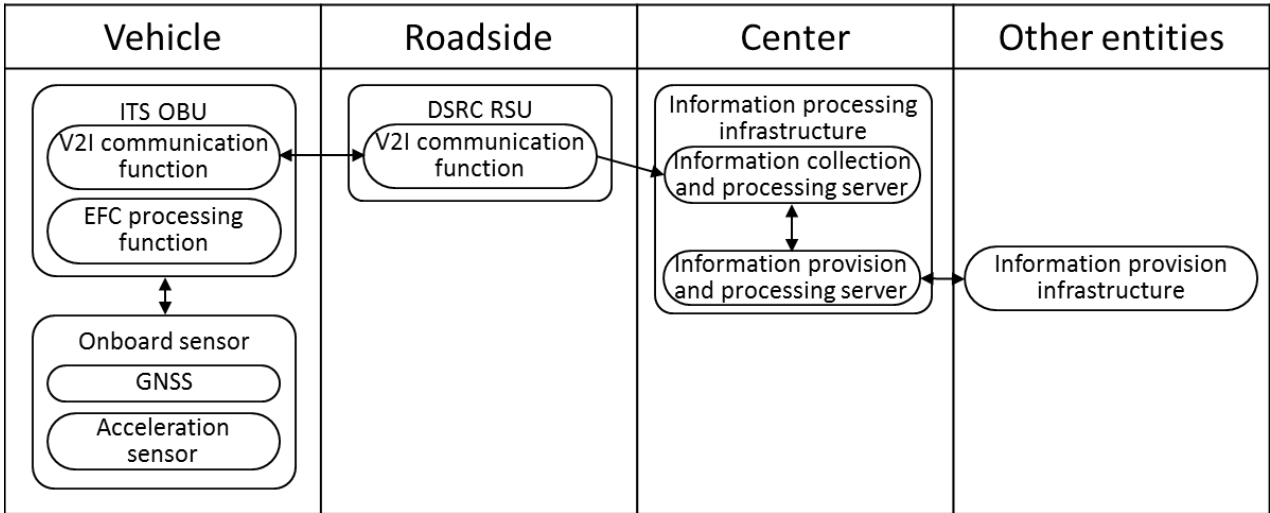
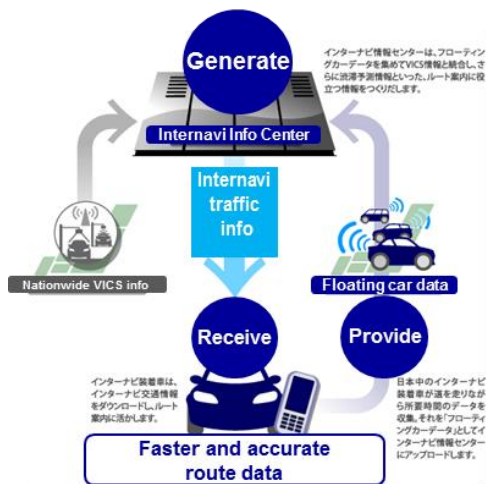

Figure 4.4-3 System configuration flow

[Reference] Examples of probe car data collection

Road traffic information collection and provision applications using probe car data have already been put to practical use in Japan. A representative example of such an application (Honda's Internavi information applications) is shown below.

In this example, road traffic information is generated on a real-time basis based on probe car data collected from more than 1.5 million members (as of March 2015) and then is provided to members on their car navigation systems and smartphone applications.



Concept of the service

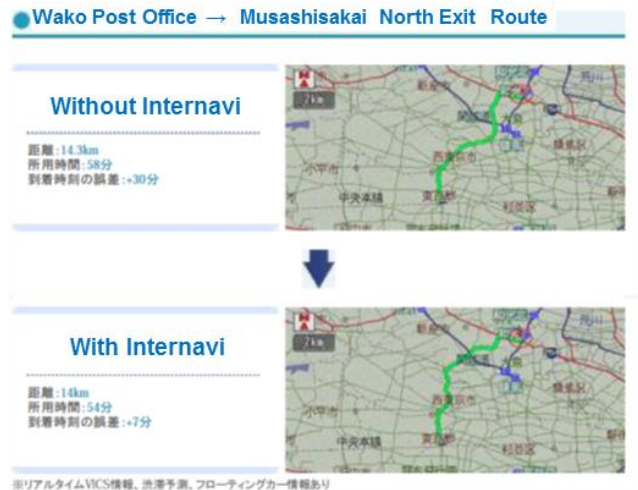

Example of road traffic information on display and the effects

Figure 4.4-4 Example of traffic information collection in Japan

Also in the case of the Great East Japan Earthquake of March 11, 2011, road travel history information collected from probe car data is published on the Internet as the Traffic Performance Map (ITS Japan published it after integrating probe data by multiple providers), which has been helpful for the promotion of rehabilitation and reconstruction efforts (Figure 4.4-5). Honda's Internavi information applications include the provision of information on disasters such as heavy rain, earthquake, as well as whiteout forecast in snowy regions.

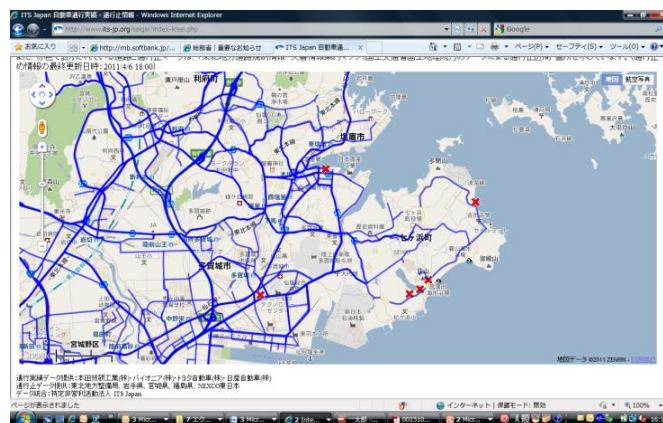

Figure 4.4-5 Example of providing the Traffic Performance Map

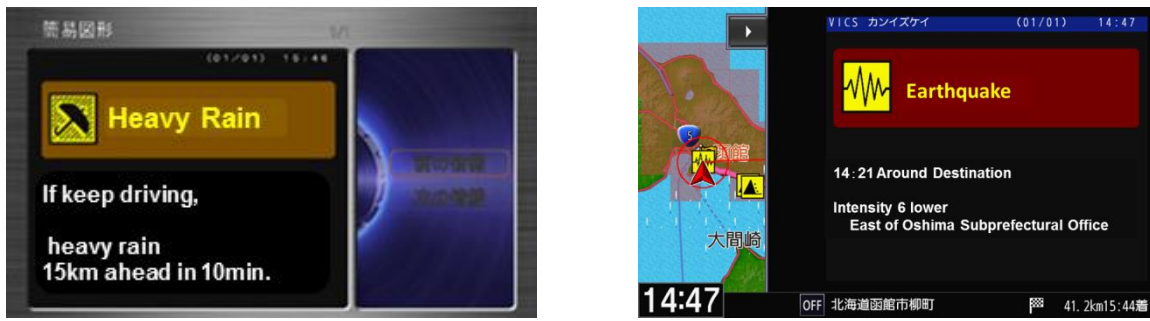

Figure 4.4-6 Example of providing information services at the time of heavy rain, earthquake

Source: Internavi homepage of Honda, <http://www.honda.co.jp/internavi/>

4.5 Road Management Using Probe Car Data

4.5.1 Contents of application

By using a probe car data system, vehicle data such as vehicle ID, time and location and acceleration, are collected via roadside DSRC antennas, on a real-time basis or periodically and are then processed by the centre to identify average travel speed, travel time, the occurrence of traffic congestion, a singular point in acceleration data, etc. The information thus identified is used for road management applications; such as developing road traffic information, information on traffic congestion based on vehicle speeds, performing traffic signal control, detecting emergent events and evaluating road repair and maintenance plans based on changes in travel speed and travel route and vehicle behaviors.

Table 4.5-1 Contents of application

Application	Contents of application
Collection of vehicle ID information	- Collection of vehicle ID information
Collection of time and location information	- Collection of travel history information including time and location information
Collection of acceleration information	- Collection of travel history information including acceleration information

4.5.2 System Configuration

An example of a conceptual framework for road management applications using a probe car data system is shown below. A system configuration for road management applications using a probe car data system consists of in-vehicle onboard unit (including an acceleration metre and communication functions), GNSS and centres (for data collection and processing, etc.).

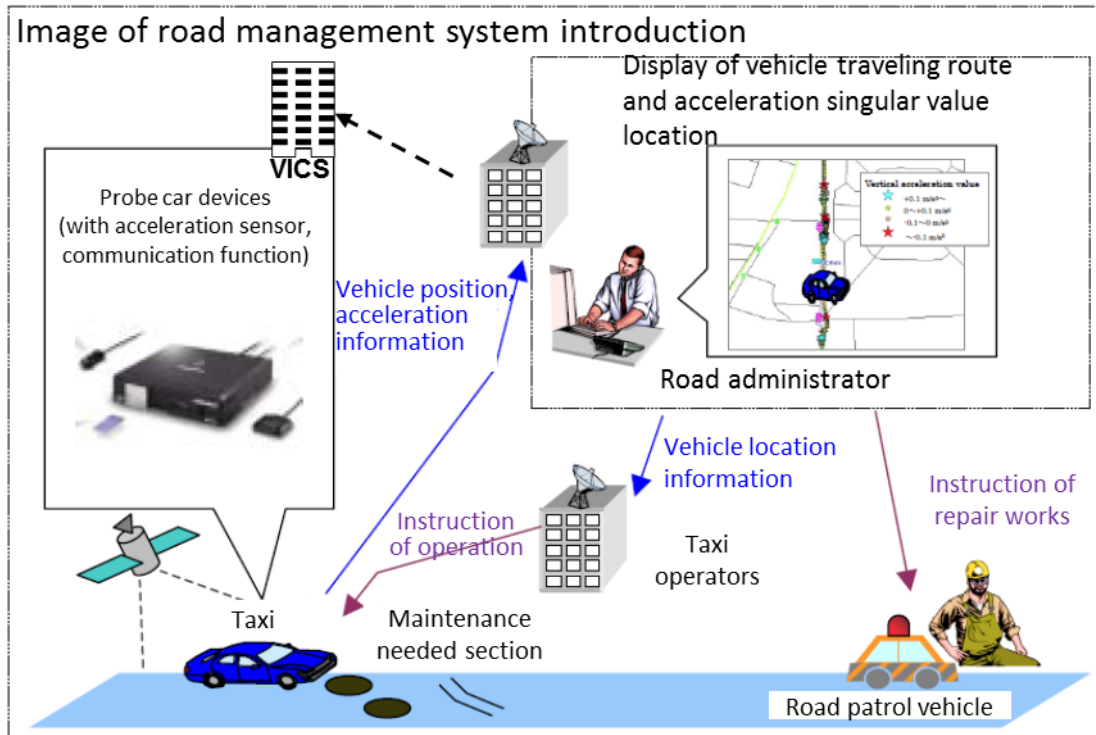

Figure 4.5-1 Image of road management using probe car data

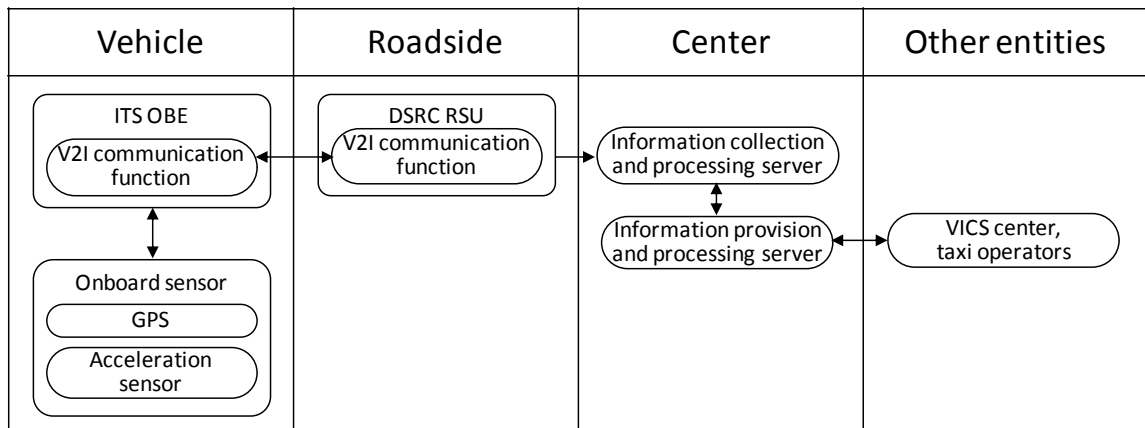

Figure 4.5-2 System configuration flow

[Reference] Examples of Road Management Using Probe car data

Road management applications using a probe car data system have been fully implemented in Japan and have produced positive results, especially in the areas of evaluating the effects of road repairs and maintenance and implementing traffic safety measures. The representative examples of such road management applications are shown as follows:

(1) Evaluation of road development and project

- “Lost time due to congestion” (which is a sum of differences between the amount of standard travel time required for a vehicle to travel a certain distance under no congestion and the amount of actual travel time for all the relevant road users) is calculated based on information on travel speeds and traffic volume of each route obtained from probe car data.
- By displaying lost time due to congestion per each route on a three-dimensional map, it is possible to readily identify heavily congested areas.

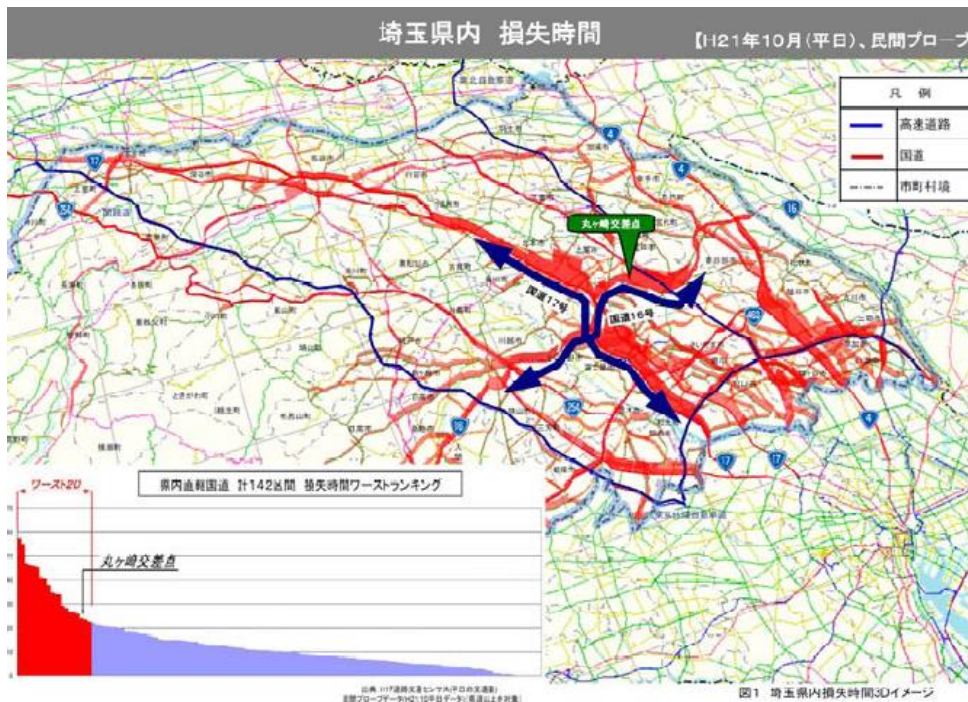

Figure 4.5-3 Example of evaluation of road development and project

Source: MLIT Kanto Regional Development Bureau
http://www.ktr.mlit.go.jp/ktr_content/content/000041593.pdf

(2) Evaluation of traffic safety measures

- Using probe car data from Honda's Internavi information applications, the locations where sudden braking (sudden deceleration) were identified and displayed on a digital map. Using this map, it was possible to compare the situation before and after the implementation of traffic safety measures.
- Such an evaluation was conducted in collaboration with the relevant local government (Saitama prefectural government).



Figure 4.5-4 Example of evaluation of traffic safety measures using probe car data

Source: Road Bureau of MLIT

(3) Information provision in time of disaster using probe car data

- In the Great East Japan earthquake, information was provided via the internet by sharing probe car data from telematics applications by private sectors and traffic regulation data by road administrators.
- Support for immediate evacuation and restoration was made possible by information sharing and provision with public and private cooperation.
- This was conducted in Typhoon No.12 which attacked Kii peninsula in September 2011 and was highly effective for use in emergency transport.

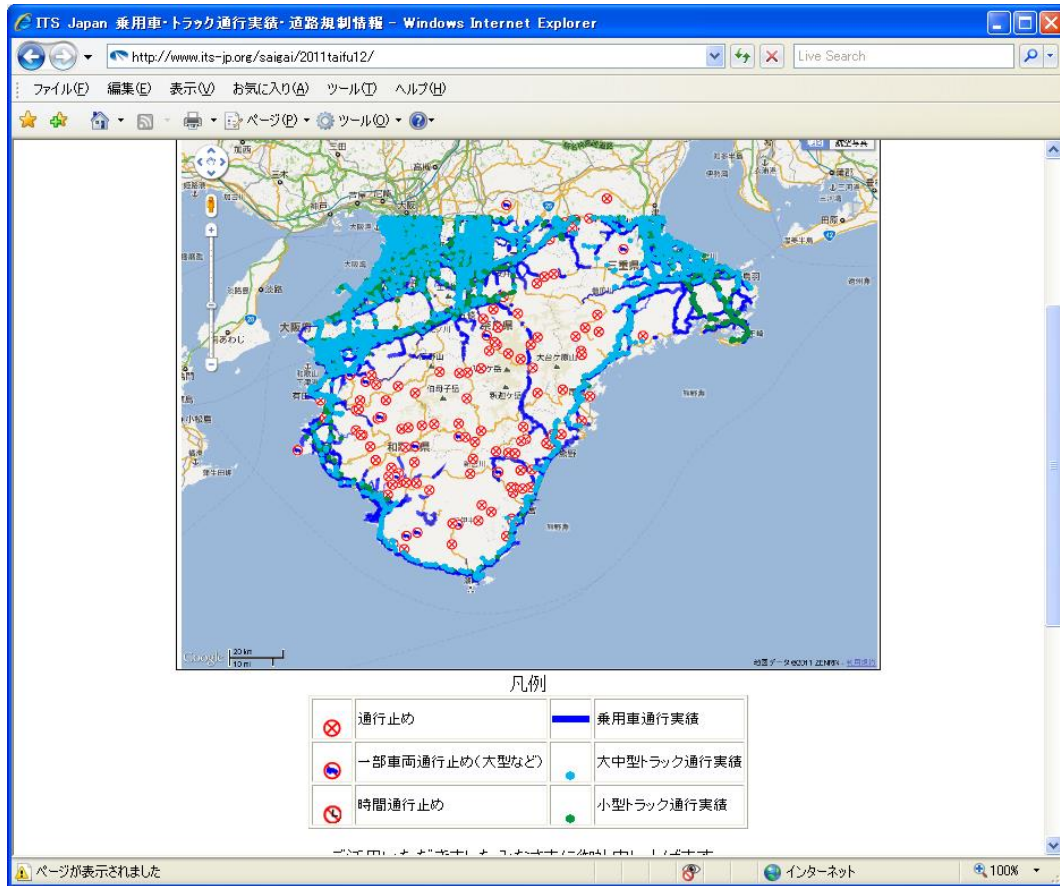

Figure 4.5-5 Example of information collection and provision on passage history in time of disaster

Source: ITS Japan

4.6 Information Provision Services on Roads

4.6.1 Contents of Applications

The roadside information provision applications are designed to provide drivers with multipurpose information in an easy-to-understand manner by using still image and voice commands, i.e. information to enhance safe driving, traffic alerts and warnings, road traffic information, including detailed information on traffic congestion/travel times in wide areas and multiple routes, and information on public transportation, amongst other things. Information to assist safe driving, which is provided in the form of text, voice commands, etc., from the standpoint of user needs and supporting driving safety, can be provided to drivers on a priority basis over other applications.

The provision of these applications is targeted at vehicles travelling on expressways and these applications must be able to be provided to vehicles travelling up to around 100kms per hour.

In Japan, IVI applications have been put to practical use to provide, on a real-time basis, a variety of road traffic information such as information on traffic congestion, accidents, road construction and parking availability in surrounding areas. Information by IVI is provided in the form of text or simple graphic or displayed on the digital map of a car navigation system.

These applications can be provided as a series of applications from the collection and processing of information to the provision of information in conjunction with the road traffic information collection applications using probe car data as specified in Section 2.4.

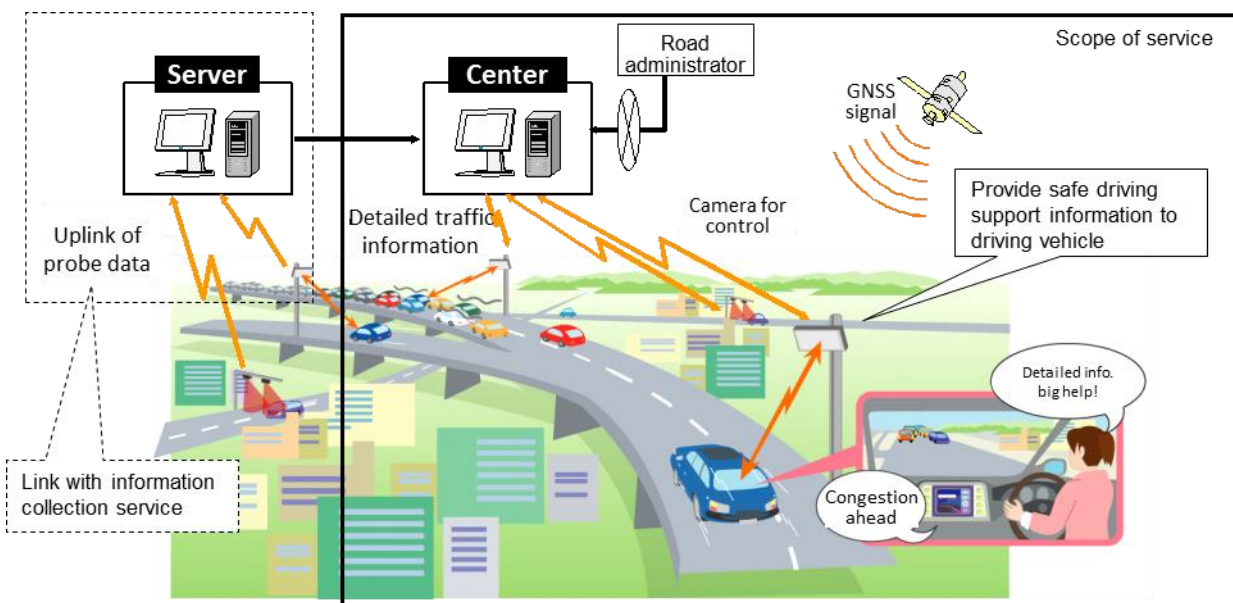

Figure 4.6-1 Image of the next generation system for information provision application on road

The six applications as shown in Table 4.6-1 are currently under study for roadside information provision applications.

Information provided by IVI applications includes information on heavy traffic and traffic congestion, information on traffic obstacles such as traffic accidents and disabled vehicles, information on traffic restriction such as road closures and lane restrictions and information on parking availability, amongst other things.

Table 4.6-1 Contents of application

Application	Contents of application
Information provision for safe driving support	- Provide information for safe driving support to drivers immediately when judging the situation danger based on collected information by roadside sensors and vehicles.
Information provision for alert	- Provide information on dangerous location to drivers by voice, grasping the condition of road surface by sensors on road and vehicles.
Information provision for multiple purposes	- Provide information on weather, rest area, and other transport modes to drivers by still image or voice.
Information provision by long sentence read	- Provide easy-to-understand information to drivers by voice and linkage with other information provision applications. - Considering in different language(s).
Information provision on congestion and required time	- Provide in wide area and detailed information. - Utilize probe car data from vehicles.
Information provision on parking	- Provide information on availability of parking lots for wide area.

4.6.2 System Configuration

There are two types of system configuration for the roadside information provision applications:

(1) Vehicle-Infrastructure-to-Vehicle Network

This is a closed network at roadside. Applications that are required to process information collected from roadside sensors and vehicles on a real-time basis and provide such information to travelling vehicles are used under this network format to provide roadside information provision applications.

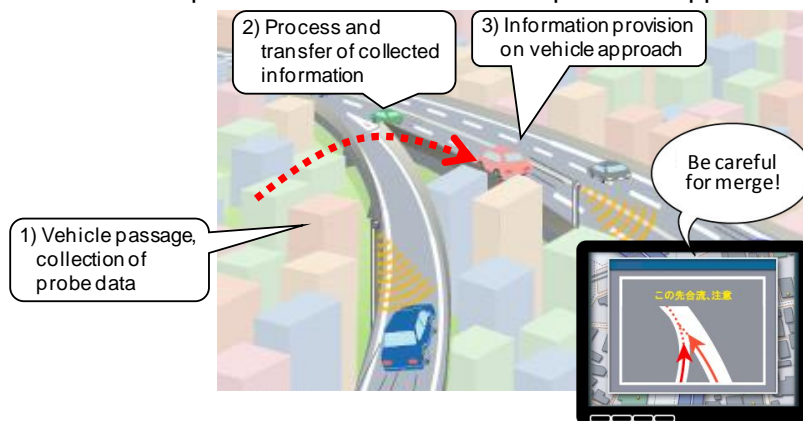

Figure 4.6-2 Image of Vehicle, Infrastructure-to-Vehicle Network

(2) Roadside Infrastructure-to-Centre Network

This network format consists of roadside infrastructures and the centre. Under this network format, all the data collected from roadside sensors and vehicles is sent to the centre. The data is then processed by the centre and then the road traffic information is provided to travelling vehicles.

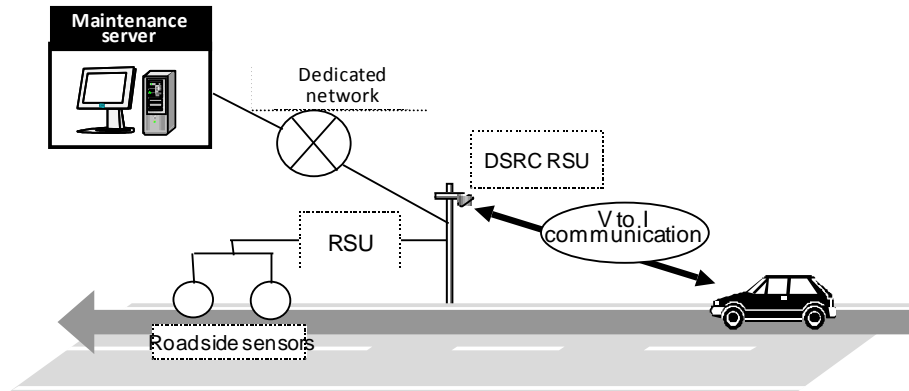

Figure 4.6-3 Roadside-sensor network

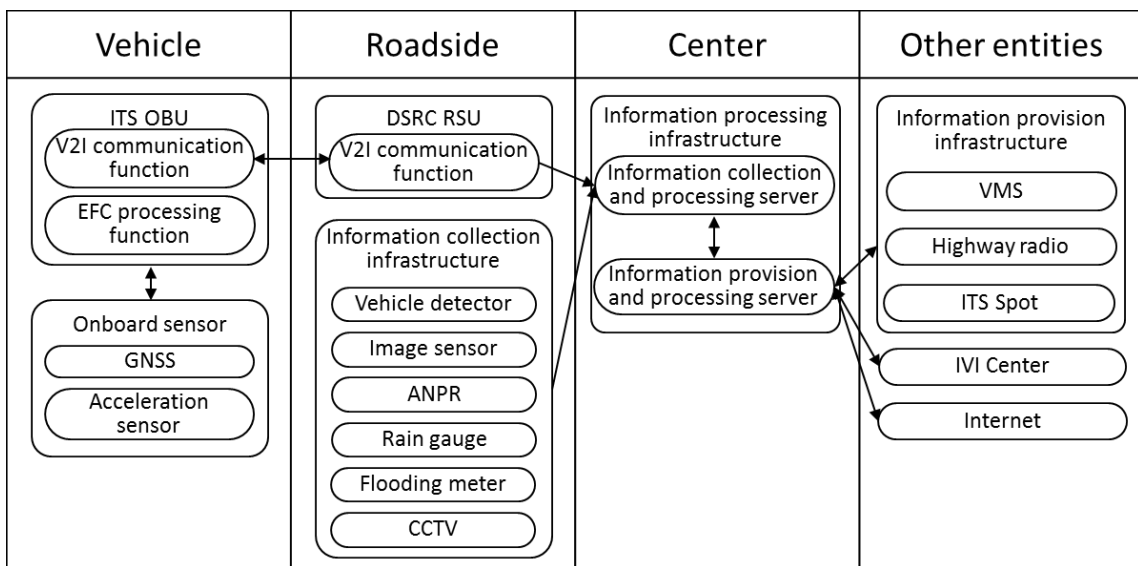

Figure 4.6-4 System configuration flow

[Reference]Conceptual System Configuration of VICS

The VICS system is made up of roadside sensors that collect traffic volume and other data, central processing units that process the collected data and information provision equipment, such as roadside beacons and FM broadcasting, which provide information to vehicles.

The VICS system can be established relatively easily by utilizing existing infrastructures, such as DSRC antennas for EFC and FM broadcasting facilities. Traffic data stored in a central processing unit can also be used for traffic signal control and other purposes.

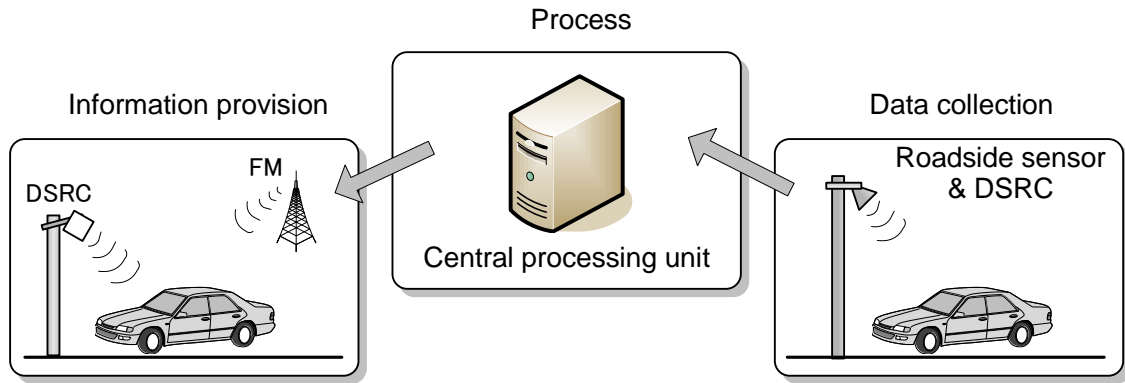

Figure 4.6-5 Image of system configuration of VICS application

Table 4.6-2 Comparison of road traffic information provision system

		Broadcast method	Information provision method
Japan	VICS	FM multiplex	Provide real time road traffic information with text, still image, and map using car navigation display.
EU	RDS-TMC	FM broadcast subcarrier	Provide real time road traffic information to dedicated OBU.

[Reference]Examples of Information Provision using VICS/DSRC

In Japan, a variety of roadside traffic information provision applications using DSRC (ITS Spot) have been put to practical use as larger capacity and more diverse roadside information provision applications. This is in addition to roadside information provision applications using VICS. Some representative examples of such roadside information provision applications are shown as follows:

1) Provision of Wide Area Traffic Information

- In intercity expressways where there are a number of routes available to choose from and in urban expressways, information on the required travel time and traffic conditions of each route is provided by using simple graphics and voice commands, and road link data for route selection (covering a distance of roughly more than 1,000 kilometers) is transmitted to a car navigation system so that it can select the optimal route.

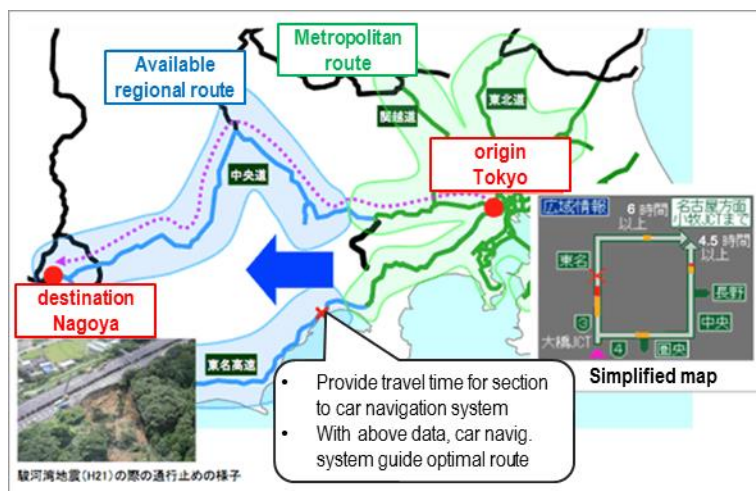

Figure 4.6-6 Example of Applications to Assist Route Selection on Intercity Expressway



Figure 4.6-7 Example of Applications to Assist Route Selection on Urban Expressway

Source: MLIT http://www.mlit.go.jp/road/ITS/j-html/spot_dsrc/index.html

2) Provision of Traffic Alerts and Warnings

- A variety of information to assist safe driving can be displayed in an easy to understand format by using simple graphics or voice commands.

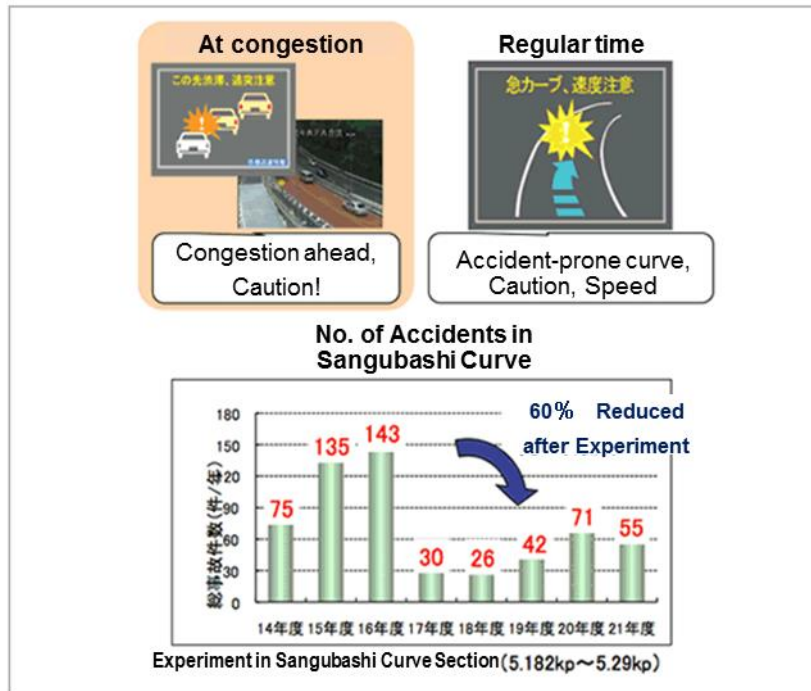

Figure 4.6-8 Example of alert information provision and effectiveness

Source: MLIT, http://www.mlit.go.jp/road/ITS/j-html/spot_dsrc/index.html

3) Provision of Multipurpose Information

- Information on parking availability, still image of parking facilities can be provided.

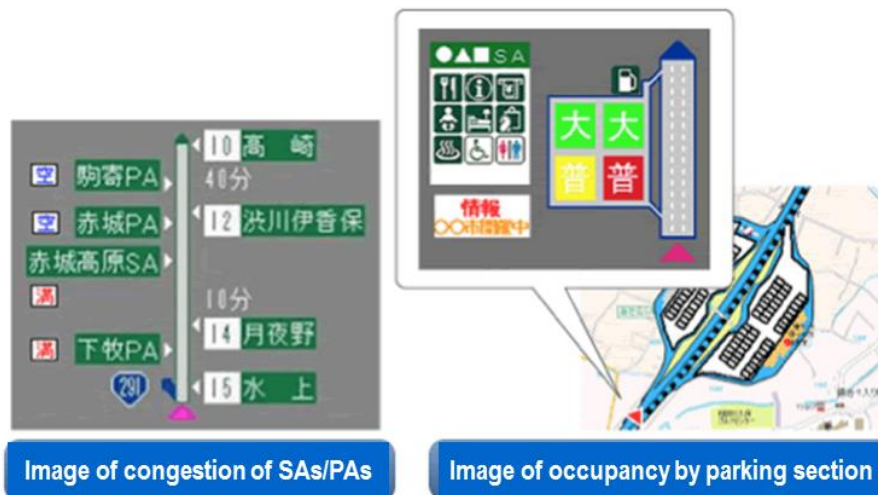

Figure 4.6-9 Example of alert information and effectiveness

Source: MLIT http://www.mlit.go.jp/road/ITS/j-html/spot_dsrc/index.html

4.7 Bus Location

4.7.1 Content of Application

The bus location system in which vehicle ID, location information and other relevant information are collected from public transit vehicles (e.g. buses) and sent to the centre for processing, is designed to provide information on bus operations to potential bus passengers via the internet or other media tools.

For example, data on a bus, such as its location (from GNSS data) and vehicle ID number, are collected by the centre using mobile phones and other media devices. The centre then provides real time information pertaining to things such as the status of bus operations - and sends notification that a bus is approaching a bus stop to potential bus passengers by means of mobile phone, the internet, information terminals, or other media devices.

As in the case of probe car data from ordinary vehicles, data on bus operations collected for this application also can be used for the provision of a variety of other applications, such as for preparing road traffic information.

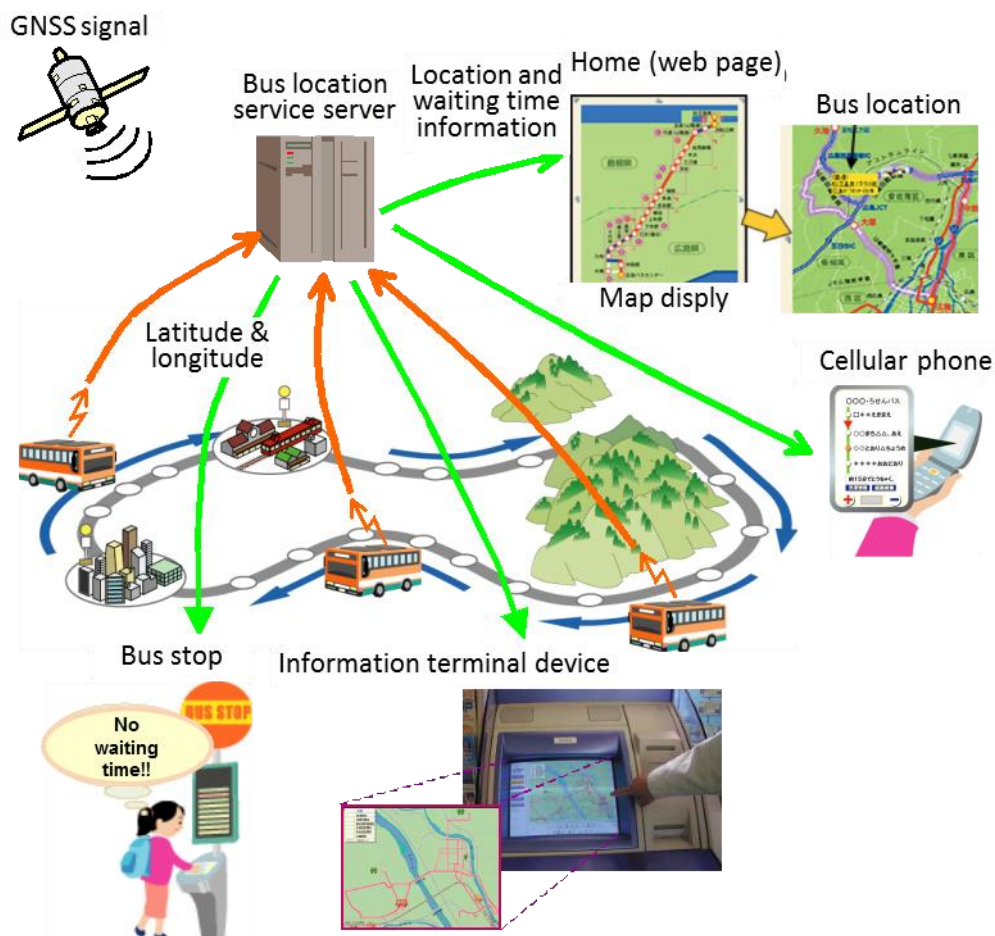

Figure 4.7-1 Image of bus location application

4.7.2 System Configuration

The typical configuration of this bus probe system is shown below.

The relevant data is sent by a bus to the centre using a mobile phone or another media device and data that is collected and analysed by the centre is distributed to home computers, mobile phones (e-mail), information terminals and other media devices via the internet.

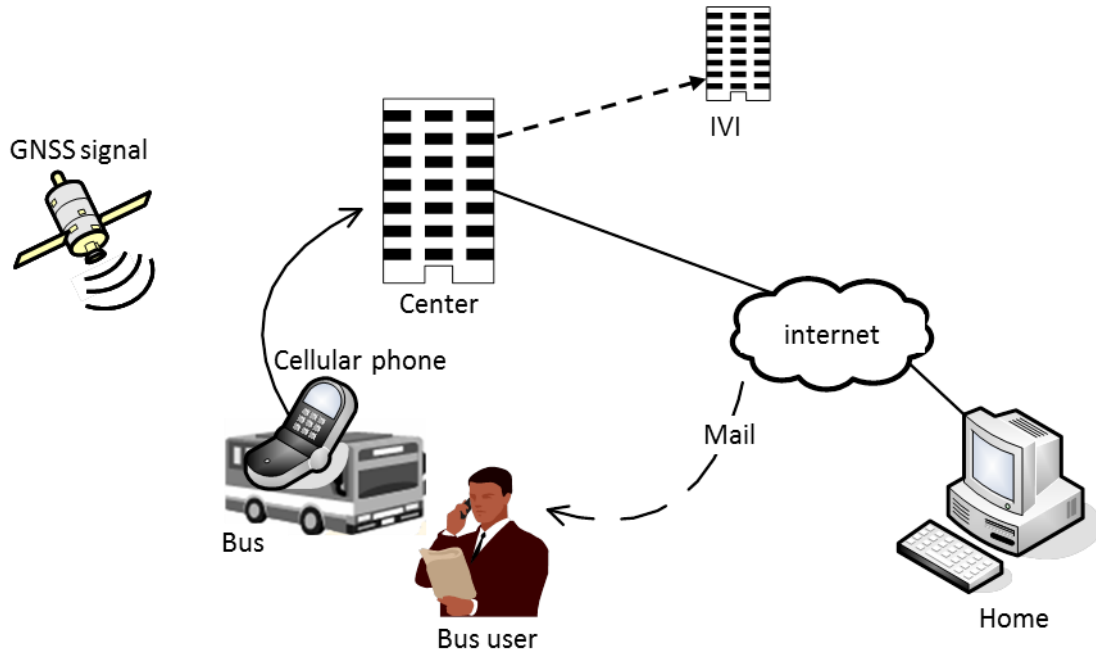

Figure 4.7-2 System configuration of bus location application

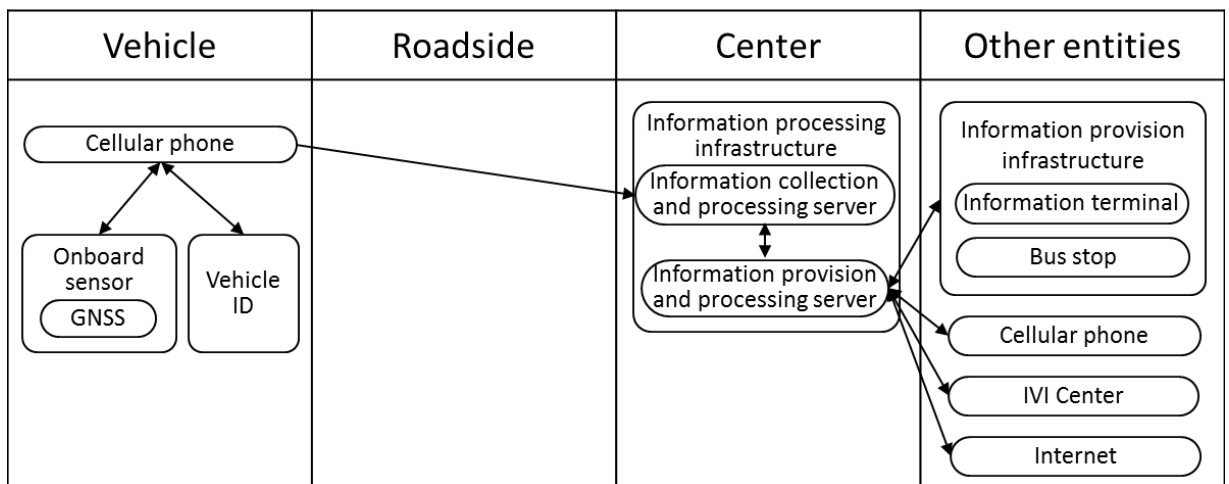

Figure 4.7-3 System configuration flow

4.8 Public Transport Priority System (PTPS)

4.8.1 Content of Application

The public transport priority system (PTPS) enables public transit vehicles such as buses to operate on roads on a priority basis. PTPS is intended to support the smooth operation of buses by controlling traffic signals, such as extending the green phase of a traffic signal on the side of the bus lane when a bus approaches a traffic signal. In Japan, the most common PTPS is to control a traffic signal by detecting buses via optical beacon-compatible onboard unit mounted on buses and optical beacons installed roadside.

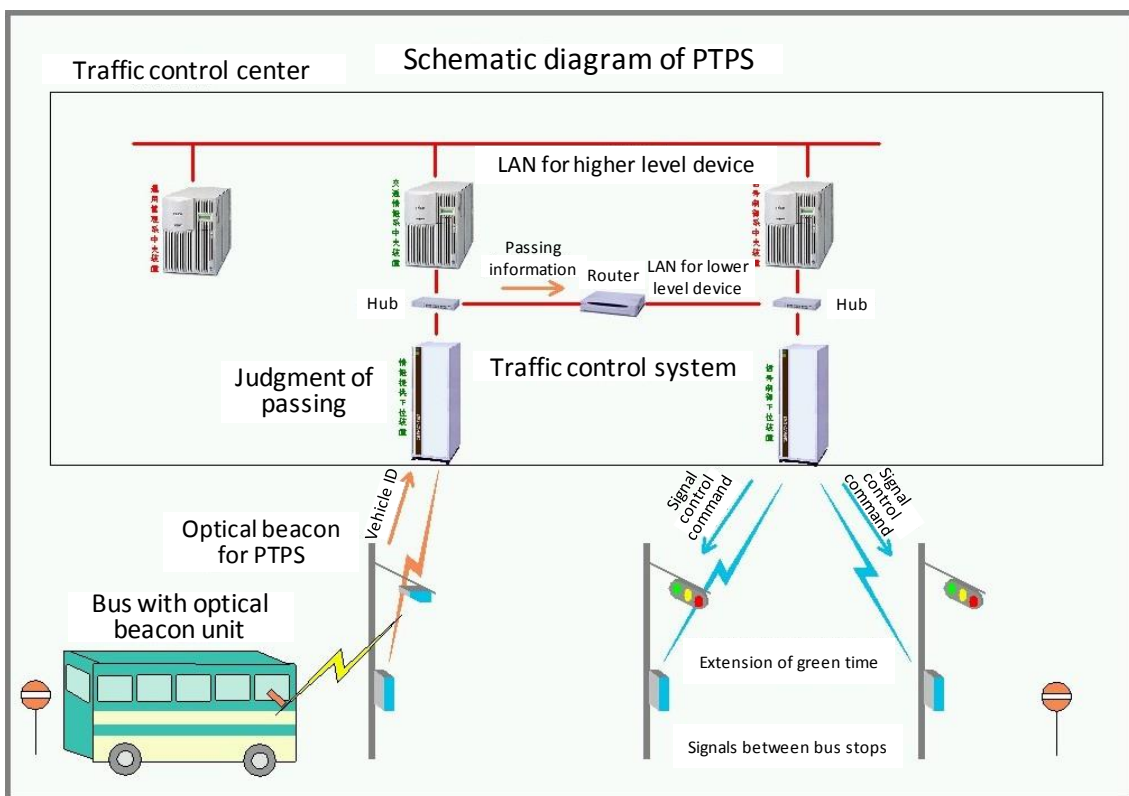

Figure 4.8-1 Image of PTPS application

Source: Police Agency for Ishikawa Pref.

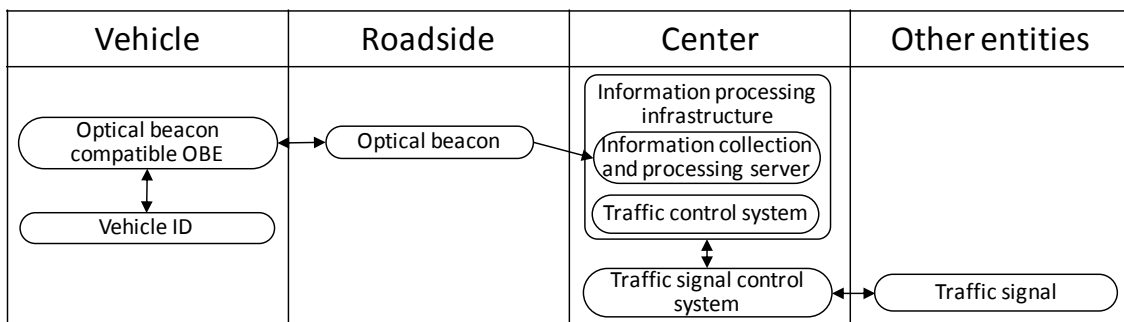

Figure 4.8-2 System configuration flow

5. Introduction and Promotion of ITS

5.1 ITS Planning and Evaluation

In this chapter, we would like to discuss key items to be noted and considered in order to successfully introduce ITS and promote the deployment of ITS according to plan.

The objectives of introducing ITS are achieving process improvements and cost reductions on the part of road managers by using probe car data systems, improving the convenience of road users using EFC, revitalizing local economies by smart IC card systems and achieving economic revitalization through the development of new commercial applications, including the provision of information. Key items to be considered vary depending on the schemes of a project. Therefore, we would like you to consider and discuss items in this chapter by fully taking into account the objectives and schemes of each project.

5.1.1 ITS Planning

- In promoting the implementation of ITS, it is important to develop the ITS introduction plan (we'll call it the "ITS Plan") to ensure efficient promotion, build consensus with stakeholders, secure budget and resources, and establish an organisational structure.
- The ITS Plan must contain its background, need and necessity, scope and positioning, ITS installation, deployment and operation plans and evaluation of ITS.

(1) Benefits of Developing ITS Plan

It is important to note that the introduction of ITS is not just about resolving certain issues. It is important to be comprehensive, taking into account all other relevant and possible plans and policies, including road and transportation plans. It is expected that the following benefits may be realized by developing the ITS Plan:

(i) Improved Efficiency

- It is expected that the ITS to be introduced will have better interchangeability, resulting in improved efficiency both for project operators and users. It is also possible to capture a synergy effect for overall greater benefits through system integration.
- It is possible to avoid overlapping investments in similar projects and research and development (R&D) initiatives.
- ITS introduction will contribute to the revitalization of industries through the expansion of ITS markets.

(ii) Building Consensus

- The plan will create a shared awareness about ITS, making it easier to obtain consensus from stakeholders and local residents and, moreover, improving the social acceptability of the project.
- Public recognition of ITS will therefore improve.

(iii) Securing of budget and resources and establishment of an organisational structure for the promotion of ITS deployment

- The ITS Plan will facilitate the securing of budget and resources and will facilitate the promotion of R&D initiatives in line with the objectives of the plan.
- The ITS Plan will facilitate the establishment of effective ITS organisational structure and systems for the promotion of ITS.
- The ITS Plan will trigger the enactment or amendment of relevant laws and regulations to support the ITS introduction, which will in turn facilitate the introduction of ITS.

(2) Process flow for the development of ITS Plan and content of ITS Plan

The typical process flow for the development of ITS Plan is outlined as follows:

(i) Background, Need, and Necessity

Specifically identify road issues in target areas and position ITS as a support tool for resolving such road issues.

(ii) Scope of the Plan

(iii) Positioning of the Plan

(iv) ITS Installation and Deployment Plans (roadmap --> solution)

(v) Necessary Platforms

(vi) ITS Operation Plan (organizational structure, popularisation of applications and onboard unit)

(vii) Evaluation Methods (to measure effectiveness and improve applications)

The ITS Plan must contain the following seven items:

(i) Background, need and necessity

Clarify the need for ITS by explaining the social background, as well as road issues that need to be addressed. It is necessary to ensure that all stakeholders share common objectives and also to obtain consensus from all stakeholders. In the “Background, Need, and Necessity” section, it is especially important to quantitatively and specifically identify road traffic issues in target areas and to position ITS as a support tool for resolving such road traffic issues in conjunction with hardware measures (such as road construction). It is also effective to introduce probe car data as a tool for quantitatively identifying road traffic issues. (Probe car data can also be utilized as a future tool for collecting and providing road traffic information.)

(ii) Scope of ITS Plan

Describe the geographical scope of the ITS Plan and the hierarchical level of the project (such as national, regional or project levels).

(iii) Positioning of ITS Plan (in relation to other road and transportation plans)

Describe the hierarchy, relationships and points of differentiation between the ITS Plan and other ITS plans or other transportation and road improvement plans. For example, a project-level plan is generally positioned subordinate to a regional or national-level plan.

(iv) ITS Installation and Deployment Plans (roadmap --> solution)

Describe the content and location of ITS installation and the future expansion plan of ITS. To be more specific, describe the content of ITS applications and regions where ITS is to be installed, as well as specific ITS applications (solutions) that are planned to be deployed in such regions. Also describe the future ITS expansion plans (roadmap).

(v) Necessary Platforms

Describe platforms necessary to ensure the introduction of the integrated and scalable ITS on a region-wide basis. Specifically, describe communication methods and data formats, among other things, that are necessary for the ITS introduction.

(vi) ITS Operation Plan (organisational structure, and popularisation of applications, onboard unit, etc.)

Describe plans for the operations of ITS once it is installed. Describe an organisational structure to support the operations of ITS and plans for the popularisation of ITS among road users (plans for the popularisation of onboard unit if the ITS applications require their installation).

(vii) Evaluation Methods (to measure effectiveness and improve applications)

Describe evaluation methods. Describe the benefits that may be obtained from the introduction of ITS, the methods for measuring such effects, measures to improve applications based on the evaluation results.

[Example of Development of ITS Plan]

(1) Example of Development of National or Regional Plan for the Introduction of ITS Applications:

1) Korea's ITS Master Plan

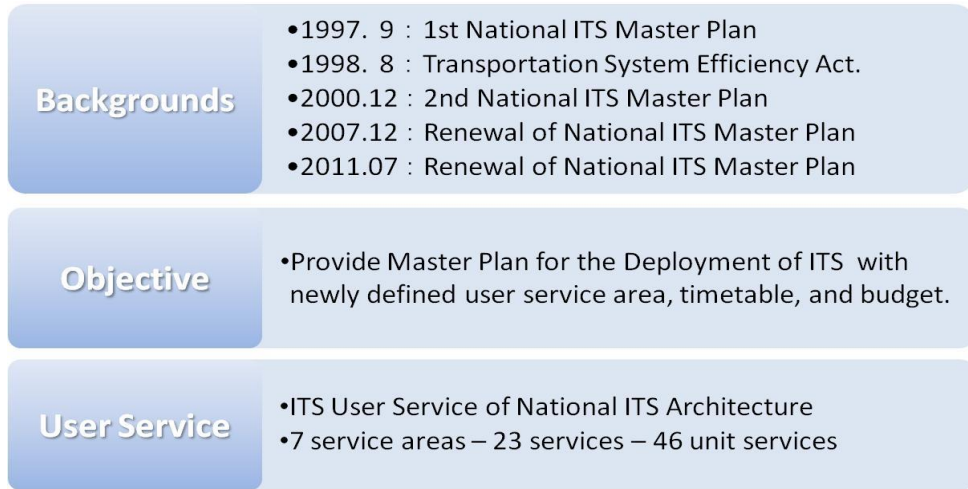

Figure 5.1-1 Outline of the master plan

• System Architecture

The National ITS Architecture categorizes ITS services into 7 main-service areas, 23 services and 46 sub-services. The seven main-service areas are traffic management, public transport, electronic payment, traffic information distribution, travel-information provision, intelligent vehicle-road and freight transportation. Among these 7 services, Korea has introduced and administered several services and systems, as illustrated below.



Figure 5.1-2 ITS Architecture and Services

2) Taiwan's ITS Master Plan

<http://www.iot.gov.tw/ct.asp?xItem=106040&CtNode=1407&mp=2>

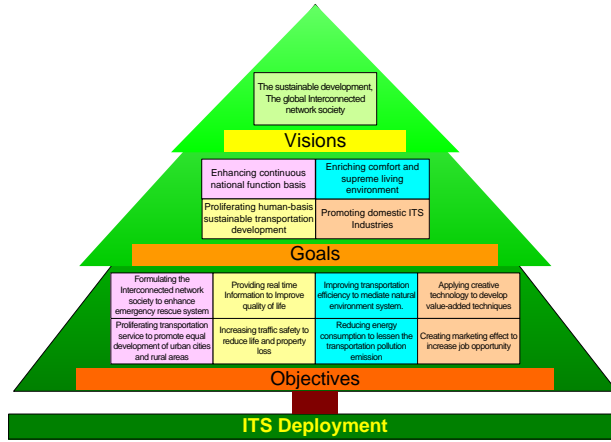

Figure 5.1-3 The visions and goals of ITS development

Table 5.1-1 ITS application areas and user application items of the master plans of 2001 and 2004 Edition

2001 edition of the master plan		2004 edition of the master plan	
Service areas	User service items	Service areas	User service items
Advanced Traffic Management Systems (ATMS)	1. traffic control 2. traffic management /signal control 3. incident management 4. whether/traffic automatic detection	1. Advanced Traffic Management Services (ATMS)	1. traffic control 2. traffic monitor 3. incident management 4. trip demand management 5. traffic environment impact management
Advanced Traveler Information Systems (ATIS)	5. route guiding 6. travel service information 7. traveling driver information 8. pre-trip travel information 9. parking information	2. Advanced Traveler Information Services (ATIS)	6. route guiding 7. travel service information 8. traveling driver information 9. pre-trip travel information 10. car pool matching and booking service
Advanced Public Transportation Systems (APTS)	10. in vehicle public transportation information 11. public transportation management	3. Advanced Public Transportation Services (APTS)	11. in vehicle public transportation information 12. operation management of public transportation 13. vehicle safety of public transportation
Commercial Vehicle Operation Systems (CVOS)	12. hazardous materials incident response 13. automatic roadside safety inspection	4. Commercial Vehicle Operation Services (CVOS)	14. automatic roadside safety inspection 15. carrier fleet management 16. on board safety monitor of commercial vehicle 17. electronic credential management of commercial vehicle 18. safety management of heavy vehicle

[Example of Development of ITS Plan]

(2) Example of Development of Plan for the Introduction of ITS Applications by Road Route:

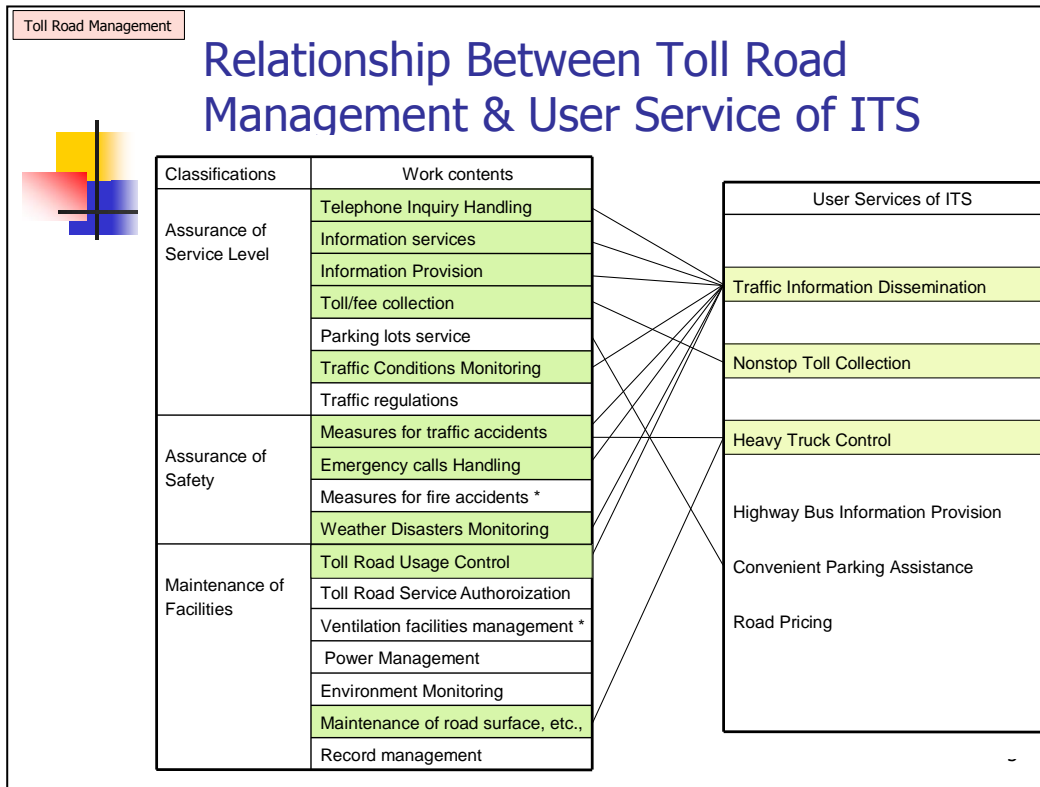

Figure 5.1-4 Example of Development of ITS Plan

5.1.2 Evaluation of ITS

- If an ITS introduction project is properly evaluated before and after, it is possible to obtain assistance from an international organisation.
- It is also important to establish a cycle for reviewing the direction of improving applications based on the evaluation results.

It is important to evaluate the effectiveness of ITS, as appropriate, once it is introduced, and to continuously make system improvements to ensure that ITS applications are provided more effectively at all times. In projects under the sponsorship of an international organisation, such as the World Bank, it is necessary to demonstrate the appropriateness of a project prior to undertaking it, with the evaluation of cost effectiveness of the project being a mandatory requirement.

In Asian countries, ITS is required to function not only as a technology but also as a social system. Therefore, in introducing ITS in these countries, it is considered more efficient to promote the introduction of ITS in stages by evaluating the effectiveness of ITS in each stage and then determining the next steps based on such evaluation results.

It is important to evaluate the effectiveness of ITS from a number of perspectives.

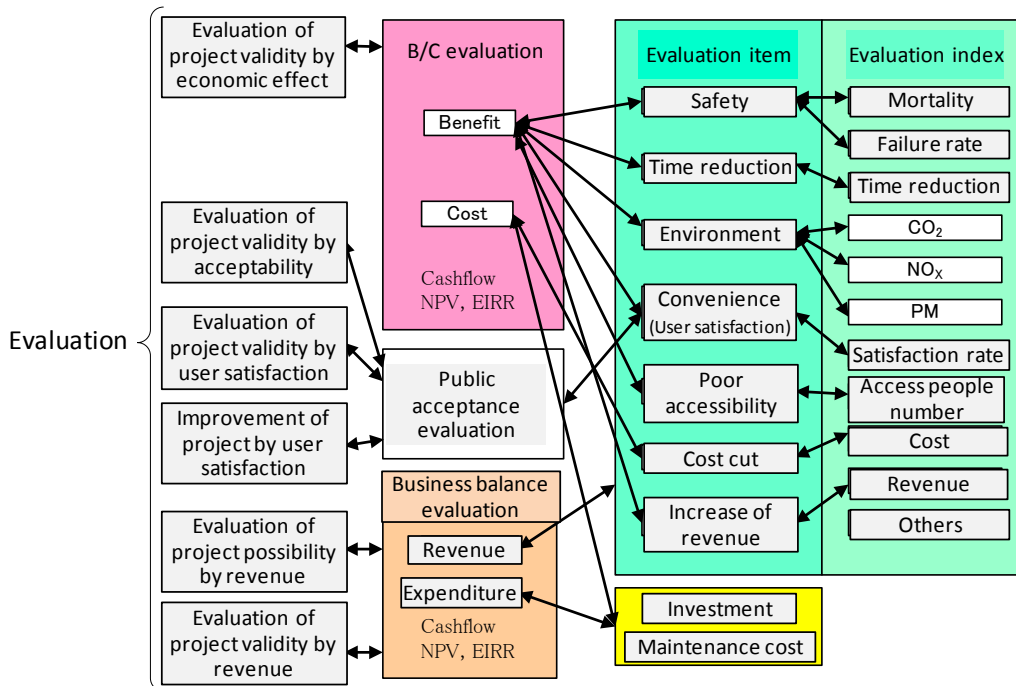

Figure 5.1-5 System for evaluation

Source: ITS Toolkit

The ITS evaluation methods are outlined as follows:

1) Evaluation Technique Using Probe car data

- Identify traffic bottleneck areas (candidate target areas for ITS introduction) prior to the introduction of ITS.
- Utilize this evaluation technique as a post-ITS introduction evaluation tool.
- Evaluate safety based on loss due to traffic congestion and acceleration/deceleration data.

2) Evaluation Technique Using Simulation

- Identify the effectiveness of the provision of road traffic information to help select alternate routes

3) Evaluation Technique Using Simulation

- Conduct questionnaire surveys and hearings for road users.

*There are cases where the effectiveness of ITS introduction was quantitatively measured by using evaluation methods, such as Contingent Valuation Method (CVM).

5.2 Items to be studied at the time of ITS Introduction

5.2.1 Project Scheme

- There are different types of schemes for the ITS introduction project. They are a public sector led scheme, a private sector led scheme and a public-private partnership (PPP).
- It is necessary to determine an optimal scheme for the introduction of ITS by taking into consideration the content of systems, financing methods and other relevant factors.

The following three project schemes are available for the introduction of ITS:

(1) Public Sector Led Scheme

This is a scheme in which ITS is introduced into the infrastructures owned by public institutions, such as governments, and is operated by a public sector organisation. The installation of ITS is financed from the road fund based on gasoline tax revenue or public coffers, such as the general budget. Financing methods may include the issuance of public bonds and loans from an international organisation, such as the World Bank, the Asian Development Bank, and the Japan Bank for International Cooperation (JBIC). It is also possible to finance the installation of ITS by issuing public bonds for road improvements and construction if ITS is introduced in synchronization with the improvement and construction of infrastructure, such as roads.

The following ITS systems are primarily based on a public sector led scheme:

- Driver information provision system
- Public transportation information provision/public transportation operation management system
- Traffic violation detection system
- Traffic control system
- Road management system, etc.

(2) Private Sector Led Scheme

This is a scheme in which ITS is introduced and operated by a private sector business operator. There are a variety of methods by which private business operators can introduce ITS, including using stand-alone onboard unit such as car navigation systems and a vehicle independent method using onboard sensors.

Financing methods, which vary depending on the strategies of the relevant business operators, may include self-financing, bank loans, and the issue of shares.

The role that the government plays in the private sector led scheme includes installing the necessary infrastructure for digital maps, which are essential for a car navigation system. In promoting the introduction of ITS in a private sector led scheme, it is necessary to ensure that the ITS standards are

consistent with other ITS standards and that the ITS Plan is consistent with the national ITS introduction plan.

Some of the ITS systems that can be introduced on a private sector led scheme are as follows:

- Advance information provision system
- Driver information provision system
- Public transportation information provision system
- Multi-modal payment system

(3) Public-Private Partnership (PPP)

The introduction of ITS based on a public-private partnership is currently being studied and implemented in advanced countries. Under this scheme, it is possible to provide sophisticated ITS applications by utilizing the private sector’s technologies and expertise and operate ITS applications more efficiently by making full use of private-sector vitality.

The following two methods are generally considered to be most suitable for ITS introduction through PPP. The first methods is to utilize private investment and expertise to build roads, and then introduce ITS such as ETC 2.0 to secure budgets for managing and maintaining roads. Installing CCTVs or other roadside systems in addition to ETC 2.0 will enable traffic information to be collected. Providing traffic information based on the information collected via IVI, GNSS navigation systems, and smartphones will support safe driving for drivers. The process involved in ITS introduction in this case is shown in Figure 5.2-1.

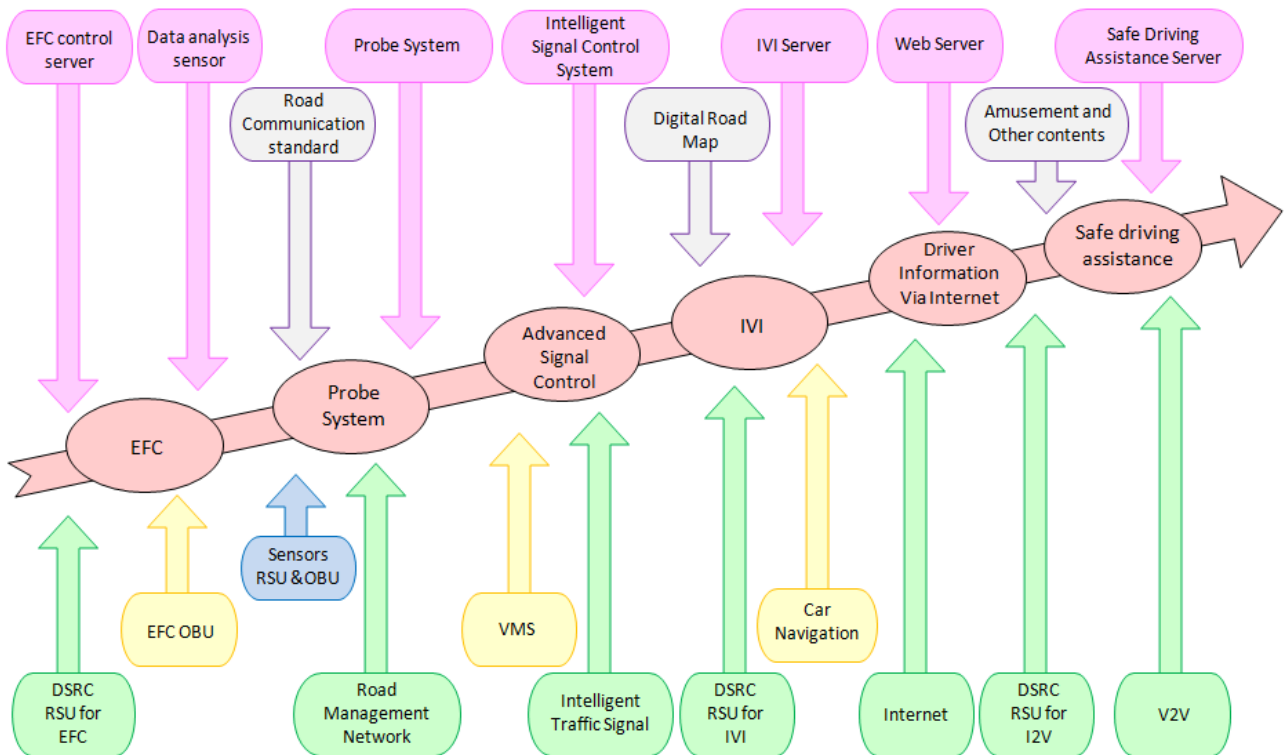

Figure 5.2-1 ITS Adoption Process Using PPP

We need to optimize the transportation system totally. First, current road network needs to be utilized. Traffic signal control and information provision to drivers are also promoted at the same time. When road network is expanded through PPP and PFI, EFC facilities are also developed. Moreover, road network is efficiently utilized using DRB and IVI (car navigation system, congestion information).

Upon introducing ITS, establishing technical platform for each system is essential in order to avoid unnecessary resources on top of building roadmap toward the system introduction. When installing roadside unit (RSU), there are various elements to be carefully considered for coordination such as EFC with probe function, traffic signal, CCTV with image processing, VMS, EFC gate, etc. In order to deploy OBU, coordination with other systems such as EFC, probe data, car navigation system with IVI, smartphones, etc. need to be carefully scrutinized. Besides, at employing communication system (e.g. 3G or 4G, Wi-Fi, DSRC), an optimal system for the region and other systems needs to be cautiously selected. If such systems are not compatible, investments on such technology development would be wasted.

Through each technology in ITS, various services could be provided. For instance, traffic information is provided to expressway users through VMS. Furthermore, by using CCTV with image processing, traffic could be monitored, and CCTV could be used as traffic counter. As stated earlier, as DSRC charges at EFC through infrastructure to vehicle communication between roadside antenna and OBU, it collects probe data, and provides DRG services to drivers through car navigation system in OBU. Then, drivers are able to avoid traffic congestions and choose less congested routes. ETC is also used to charge at a certain zone to restrict vehicle inflow for the purpose of protecting safety for pedestrians and bicyclists.

The second method utilizes PPP on roads developed. This entails authorized providers leasing land free of charge for predetermined period of time to display advertisements on Variable Message Signs (VMS) or other information provision equipment, with the revenue generated from these advertisements are used to manage and maintain the ITS equipment. In addition to road administrators providing traffic information on the information boards, CCTVs and probe information collection devices are installed roadside to collect information. As in the first method, this method provides motorists with traffic information based on the information collected.

Figure 5.2-3 shows an example of the second PPP method in Ahmadabad, India. In this example, a Japanese road information signboard manufacturer supported by JICA leased land free of charge and installed a VMS. A half of the screen displays sponsor advertisements, and the revenues are used to manage and maintain the equipment. The other half of the screen displays information on road works and traffic congestion, and other information that the road administrator provides. This information is created from data collected by sensors that have been installed besides the information board, and drivers are able to see the VMS display contents and traffic information on tablet terminals. This service is expected to provide traffic information to car navigation systems in the future.

[Example of PPP (Public-Private Partnership)]

Following is an example of PPP in Ahmadabad, India. In this example, a Japanese VMS manufacturer rented land free of charge by assistance of JICA and installed VMS. On half of VMS display, a sponsor provides advertisement, and the manufacturer maintains the VMS devices using advertising revenue from sponsors. On the other half of the display, road administrators provide information such as information on road work, congestion, etc.

Congestion information is generated using data collected through sensors installed together with the information service equipment, and is provided on smartphones and tablets as well. In the future, such information is expected to be also available with car navigation system.



Figure 5.2-2 Example of display of advertising and traffic information on VMS

Source: Nagoya Electric Works CO. LTD

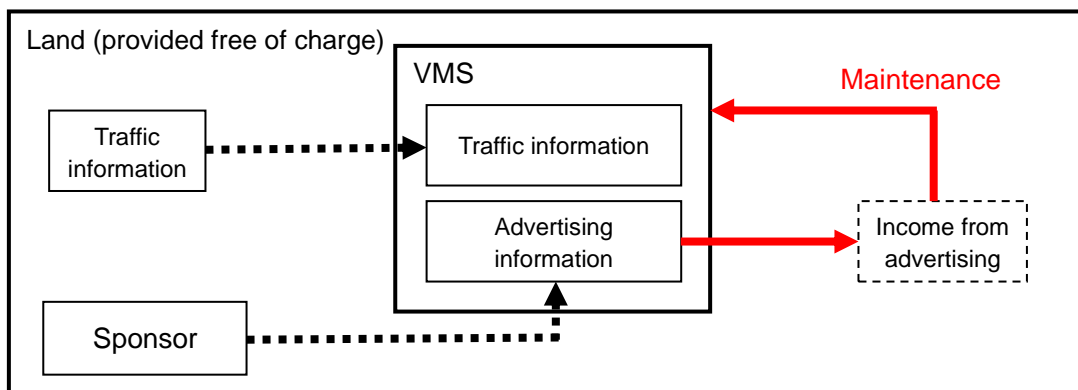

Figure 5.2-3 Image of project configuration

[Reference] Availability of Assistance from the Japanese Government

Japanese government's assistance may be made available mainly for public sector-led projects and public-private joint projects.

(1) Action Necessary to Obtain Japanese Government's Assistance

If you desire assistance from the Japanese government, as a general rule you must submit a request for assistance to the Japanese embassy in your country. You will be able to receive technical, financial, or other assistance from the Japanese government if your request is approved.

Model procedures from the submission of a request to the introduction of ITS are outlined as follows:

1) Preparation and Submission of Request for Assistance

In preparing a request for assistance, you must clarify the current status of road traffic conditions in your country, countermeasures that you plan to undertake (what type of ITS you are planning to introduce) and the content of your request (type of loans that you desire to obtain, etc.). The request is then submitted to the Japanese embassy in your country.

As the preparation of a request like this requires a variety of expertise and knowledge, it is recommended that you work together with the organisation described below. As no official development assistance (ODA) schemes for ITS are currently available in Japan, it is necessary to be creative; introduce ITS as part of a social infrastructure development and improvement program, such as put forward the idea of ITS in conjunction with road improvements and construction.

2) Implementation of Development Survey

If your request for assistance is approved, a development survey will be carried out prior to the implementation of a project (such as road construction). The Japan International Cooperation Agency (JICA) will carry out the development survey to identify the current state of affairs and road traffic conditions in your country, as well as needs, market size and economic benefits for the project, among other things. JICA will also review the project scheme as part of this development survey.

3) Project Implementation

If the need for the project is approved as a result of the development survey, the project will be implemented in line with the project scheme validated by the survey result.

(2) Types of Assistance from the Japanese Government

The main types of assistance provided by the Japanese government are outlined as follows:

1) Technical Assistance

- Dispatch of Japanese specialists with expertise in their fields via JICA
- Provision of technical information and information on expertise, ITS toolkit, ITS introduction guide

2) Financial Assistance

- Provision of grant assistance by JICA Grant assistance is more likely to be provided to projects which implement measures to fight poverty, installation of public transportation systems (such as bus location and traffic control systems), safety planning, and reduction of traffic accidents.
- Loan assistance by JBIC or the World Bank.

3) Other Assistance

- Provision of credit guarantee

The Japanese government will create a favourable investment environment by providing a credit guarantee to the ITS introduction project to encourage Japanese private enterprises to take part in the ITS introduction and installation project.

- Assistance for Personnel Training and Education in Japan

Training and education will be conducted in Japan concerning technical information about ITS to develop personnel who can take the lead in the local installation of ITS.

5.2.2 Legal System

- It is necessary to fully understand the laws and regulations that are applicable to ITS systems and ensure that the ITS system specifications are in full compliance with these.
- It is also necessary to study the enactment or amendment of applicable laws and regulations.

ITS is made up of roads, vehicles and communications and a wide variety of laws and regulations are therefore applied to ITS. (See Figure 5.2-4) If the ITS that plans to be introduced affects the existing laws and regulations, it is necessary to review the content of ITS applications and their installation methods.

Roads: Laws and regulations related to road infrastructures must be carefully reviewed as ITS requires the roadside installation of information collection devices, such as CCTV and sensors, and information provision devices, such as VMS.

Traffic Safety and Traffic Regulation: There are laws relating to overall traffic regulation to ensure safety and regulatory requirements for transport business operators, including the transportation of passengers, and the ownership, repair and maintenance of vehicles. In recent years, laws and regulations to regulate the use of electronic devices while driving a vehicle have been enacted in an increasing number of countries.

Radio Wave: There are a variety of conditions for and restrictions on the use of radio waves. Permission, or at the very minimum, notification, is usually required in advance from regulatory authorities to use radio waves. It is necessary to pay careful attention to all applicable laws and regulations on radio waves when introducing ITS that utilizes radio waves such as EFC.

Environment: Careful attention must be paid to the laws and regulations surrounding the environment, such as air pollution, noise and vibration.

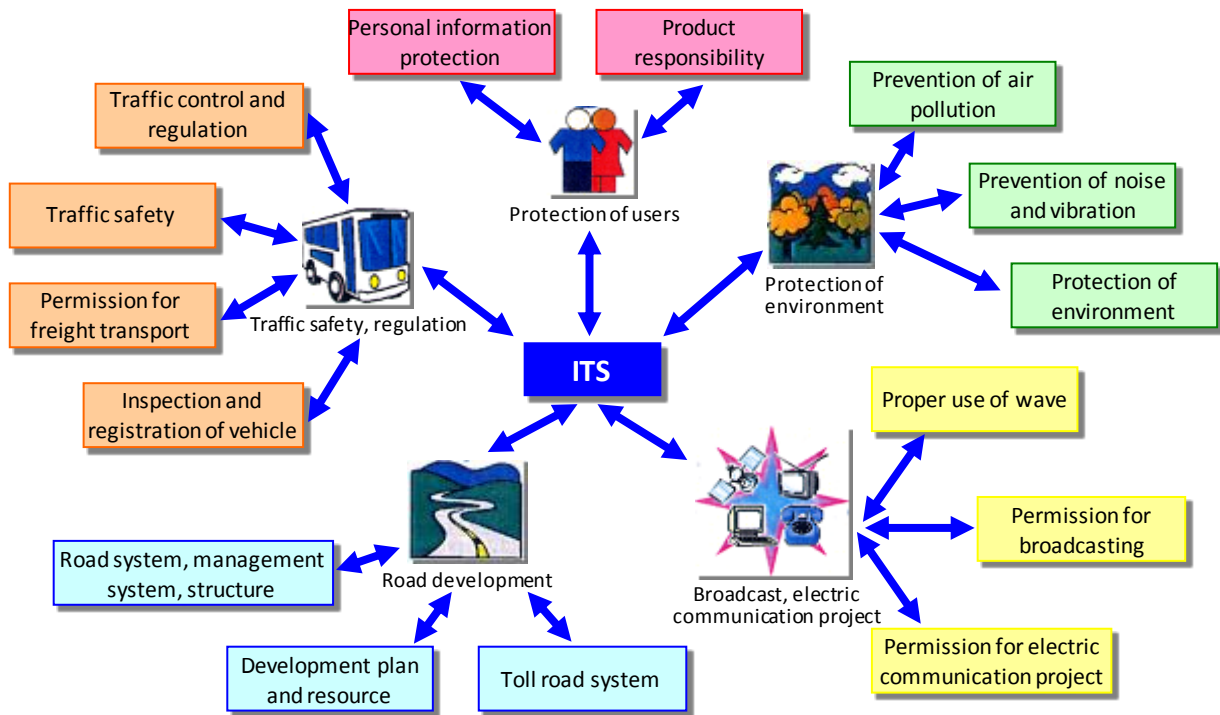

Figure 5.2-4 Legal system on ITS

Source: ITS Toolkit

[Reference] Examples of ITS-Related Laws and Regulations in Japan

- Radio Act (which regulates the use of radio waves)
- Telecommunications Business Act (which applies to the utilization of optical fibre networks.)
- Road Act (which applies to the roadside installation of ITS-related facilities)
- Ministerial Ordinance about Free Accommodation and Grant of Articles which Belong to the Ministry of Land, Infrastructure, Transport and Tourism (which applies to the opening up of public infrastructures such as antennas to the private sector)
- Act on the Protection of Personal Information (which applies to the handling of personal information via probe car data, EFC)
- Product Liability Act (which applies, amongst other things, to traffic accidents that are caused due to an erroneous operation of ITS onboard unit)

5.2.3 Protection of Personal Information

- It is important to ensure the protection of personal information when introducing a system that handles personal information, such as EFC.
- For example, special attention should be paid to ensuring sufficient control over access to and storage of personal information, as well as methods of communication including personal information.
- It is also necessary to study and implement measures to prevent fraudulent activities via system intrusion, such as falsification of information, wiretapping and masquerading.

As a variety of ITS applications include payment applications, such as EFC, and involve systems for the collection of user information, such as probe car data systems, it is imperative that users' personal information is protected. In the case of EFC for example, information on the location of and time of passage at toll gates, payment-related information etc., are deemed to be "personal information." It is necessary to fully study and implement measures to ensure sufficient control over access to and storage of such personal information, as well as methods of communication including personal information.

The protection of personal information act has been signed into law in all of the 30 member countries (as of 2002) of the Organisation for Economic Cooperation and Development (OECD).

Table 5.2-1 Laws on privacy in OECD members

Country	Laws
Australia	Privacy Act (Legislated in 1988, Revised in 2000)
Austria	Federal Data Protection Act (Legislated in 1978, Revised in 1994)
Belgium	Law on the Protection of Privacy Regarding the Processing of Personal Data (Legislated in 1992, Revised in 1999)
Canada	Privacy Act (Legislated in 1982) Personal Information Protection and Electronic Documents Act (Legislated in 1999)
Czech Republic	The Protection of Personal Data in Information Systems Act (Legislated in 1992)
Denmark	The Act on Processing of Personal Data (Legislated in 2000)
Finland	Personal Data Act (Legislated in 1987, Revised in 1999)
France	Act on Data Processing, Data Files and Individual Liberties (Legislated in 1978, Revised in 1994)
Germany	Federal Data Protection Act
Greece	Protection of the Individual Against Processing of Personal Data (Legislated in 1997)
Hungary	The Law on Protection of Personal Data and Disclosure of Data of Public Interest (Legislated in 1992)
Iceland	Act Nr.121 Concerning the Registration and Handling of Personal Data (Legislated in 1989)
Ireland	Data Protection Act (Legislated in 1988)
Italy	Law on Protection of Individuals and Other Subjects Regarding the Processing of Personal Data (Legislated in 1996)
Japan	Act for protection of computer Processed Personal Data held by Administrative Organs (Legislated in 1988)
Korea	The Protection of Personal Information by Public Organizations Act (Legislated in 1994)
Luxembourg	Nominal Data (Automatic Processing) Act (Legislated in 1979)
Mexico	Law on federal transparency and access to public information (Legislated in 2002)
Netherlands	Data Protection Act (Legislated in 1988, Revised in 1993)

Country	Laws
New Zealand	Privacy Act 1993 (Legislated in 1993)
Norway	Act Relating to Personal Data Registers (Legislated in 1978, Revised in 1994)
Poland	Act on the Protection of Personal Data (Legislated in 1997)
Portugal	Protection of Personal Data Act (Legislated in 1991, Revised in 1994, 1998)
Slovakia	The Protection of Personal Data in Information Systems Act (Legislated in 1992)
Spain	Law on the Regulation of the Automated Processing of Personal Data (Legislated in 1992, Revised in 1999)
Sweden	Personal Data Act (Legislated in 1973, Revised in 1992, 1998)
Switzerland	Federal Law on Data Protection (Legislated in 1992)
Turkey	Bill on Data Protection
United Kingdom	Data Protection Act 1998
United States	Privacy Act of 1974 (Legislated in 1974, Revised in 1988)

[Reference] Privacy Protection in Japan

In Japan, the collection of probe car data utilizing DSRC communications started in March 2011. To ensure personal information is protected, the road bureau's notices and requests concerning the protection of personal information are posted on the website of the road bureau of the Ministry of Land, Infrastructure, Transport and Tourism.

- Notices and Requests concerning Protection of Personal Information ("ITS Spot" page of the website of the Road Bureau of the Ministry of Land, Infrastructure, Transport and Tourism)

http://www.mlit.go.jp/road/ITS/j-html/spot_dsdc/oshirase.html

*In order to ensure the protection of personal information, it is stated in the relevant website page that probe car data is processed in ways so that the direct identification of an individual can be avoided (such as aggregation of data and hiding locations of departure and arrival for processing).

5.3 Items to be studied to ensure the Smooth Promotion of ITS

5.3.1 Establishment of ITS Promotion Organization

- By establishing an organisation for the promotion of ITS, it is possible to work closely and effectively with other related organizations and ensure that information is shared among the related organisations smoothly.
- In Asian countries, we consider it more effective to establish an organisation that is led by governmental agencies and research institutes, such as universities, for the purpose of the promotion of ITS.

In order to ensure ITS is promoted according to plan, it is more effective to put an organisation in place to do this. If this organisation is put in place on a national and/or regional basis, it is possible to work closely and effectively with other related organisations, ensuring information is shared among the related organisations more smoothly.

The potential participating members of an ITS promotion organisation such as this may include the related governmental ministries and agencies, developers, as well as intellectuals, experts and private sector business operators in the fields of civil engineering, electronics and communications. ITS Japan has been established by private sector organisations and universities with the cooperation of governmental agencies. In the United States, ITS America has been established under the leadership of the U.S. Department of Transportation.

In order to ensure ITS is promoted consistently across Asian countries, including small territorial islands, it is recommended that public organisations such as governmental agencies take the lead in these efforts. We consider it more effective to systematically implement the introduction of ITS by taking the following approaches: (i) establish ITS promotion organisation under the leadership of research institutions, such as universities, and governmental agencies, (ii) hold study sessions, workshops, etc., to hold together the related organisations such as governmental agencies and private enterprises, and (iii) select research themes and projects for the said study sessions and conduct trial tests.

[Reference] ITS Promotion System in Japan

In Japan, ITS is being promoted as a national endeavor under the leadership of the IT Strategic Headquarters (Directors General: Prime Minister) and with the cooperation of the four governmental ministries which are related to ITS. In addition, ITS is also being promoted jointly by industry and academia with the establishment of ITS Japan with the participation of academic experts in the related fields and representatives of related private enterprises and organisations.

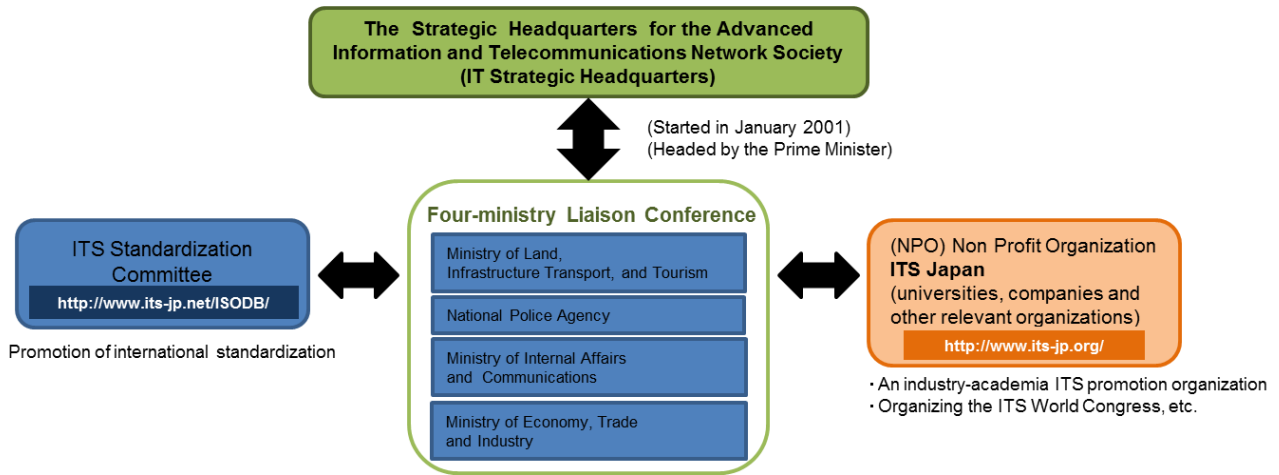

Figure 5.3-1 ITS promotion system in Japan

Source: Highway Industry Development Organization, ITS Handbook

【Reference】 ITS Promotion System in Thailand

ITS in Thailand has been promoted by several agencies. Ministry of Transport published Thailand ITS Master Plan, which addresses the vision and what-to-do to national transport system. Ministry of Science and Technology has also engaged many research, development, and promotion of ITS. Although the formal coordination body among government ministries and among other stakeholders has not been established, networking of ITS has been done through many affairs, especially through Thai ITS Association (ITS Thailand). ITS Thailand coordinates ITS matters among organizations, which lead to knowledge transfer and direction making in ITS development in Thailand. As a result, industry and academia can also join ITS activities with government and take part of ITS implementation.

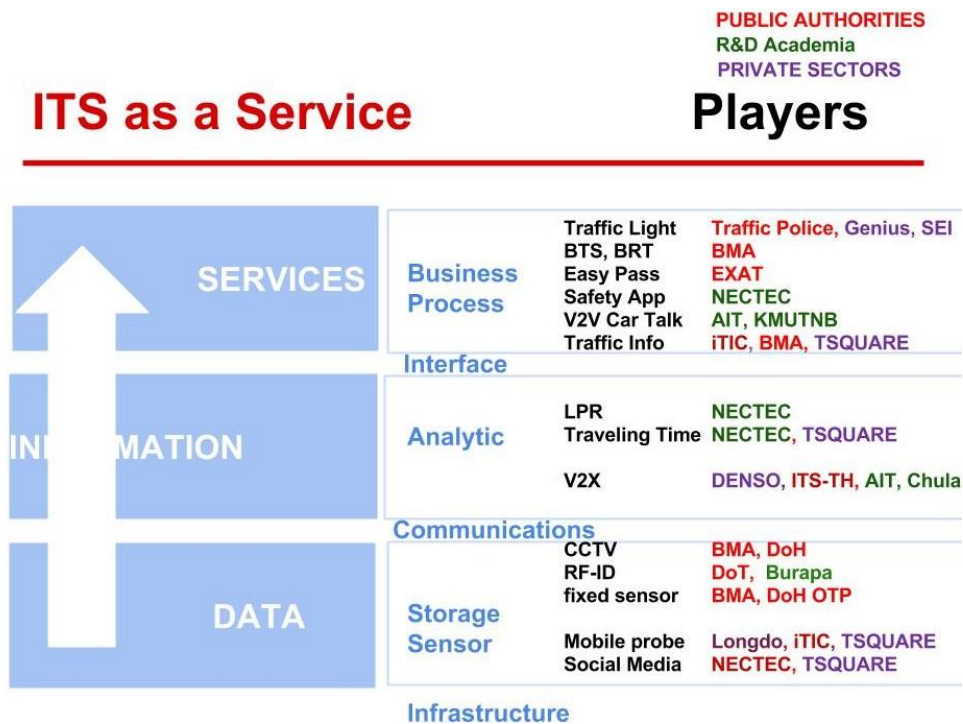

Figure 5.3-2 ITS service planning as a result of coordination among several players in Thailand

Reference: ITS Thailand

5.3.2 Utilization of Standards and Development of National Standards

- It is important to establish national standards for ITS systems to ensure their interchangeability and future scalability.
- By establishing the ITS system architecture, installing servers, and establishing road communication standards and common data platforms, it is possible to secure the interchangeability and scalability of ITS systems and to ensure the development of common understanding on ITS among stakeholders.

As ITS is a social system utilizing information technologies (IT), it is necessary to update ITS-related devices and ensure the functional scalability of ITS systems to keep pace with technological developments and changing user needs. Therefore, it is likely that different ITS systems may be introduced in different regions or adjacent regions in a country due to differences in introduction timing. In that case, if, for example, users have to purchase different EFC onboard unit for use in different regions, they most likely will not utilize such ITS systems because of inconvenience. In addition, it may be difficult to expand such ITS systems in the future.

Therefore, it is important to ensure the interchangeability and future scalability of ITS systems by establishing uniform national standards for ITS-related devices and dataset. In addition, if these national standards are consistent with international standards, it is possible to procure high-quality systems at lower cost and to study the feasibility of the interoperation of ITS with neighbouring countries with land borders.

By establishing such national standards, it is possible to eliminate time and effort for designing the structure of data and building a consensus among stakeholders every time a system is added, which results in reducing required time and costs as well as contributing to the earlier introduction of ITS.

(1) Establishment of ITS System Architecture

The ITS system architecture, which is a design drawing showing an overall configuration of ITS systems, defines the components of ITS systems and their relationships. The objectives of the establishment of the ITS system architecture are to (i) develop comprehensive ITS systems in an efficient manner, (ii) ensure the scalability of ITS systems, (iii) promote the development of national and international standards for ITS systems, and (iv) develop common understanding on ITS systems among system developers.

The establishment of the ITS system architecture is very effective in ensuring the interchangeability, scalability, interoperability and integration of ITS systems. In Asian countries, it is difficult to establish the ITS system architecture that encompasses all user applications for the following reasons: (i) roads and public transportation infrastructures are rapidly growing and changing, (ii) the environment in which ITS is implemented is greatly changing due to the advancement of motorisation and IT, (iii) road traffic systems

may change in line with these changes, and (iv) user awareness and needs may also change accordingly. For this reason, it is recommended that the ITS system architecture be developed in stages by carefully studying the ITS system architecture of other countries and regions, etc.

[Reference] ITS System Architecture in Japan

In order to clarify information and functions that are necessary for providing ITS applications, ITS applications are systematically grouped into nine development areas, 21 user services, and 172 user sub-services.

For each user sub-service, the specific content and system configuration diagram are defined in detail. (See the following chart. An excerpt of a systematic chart for ITS applications)

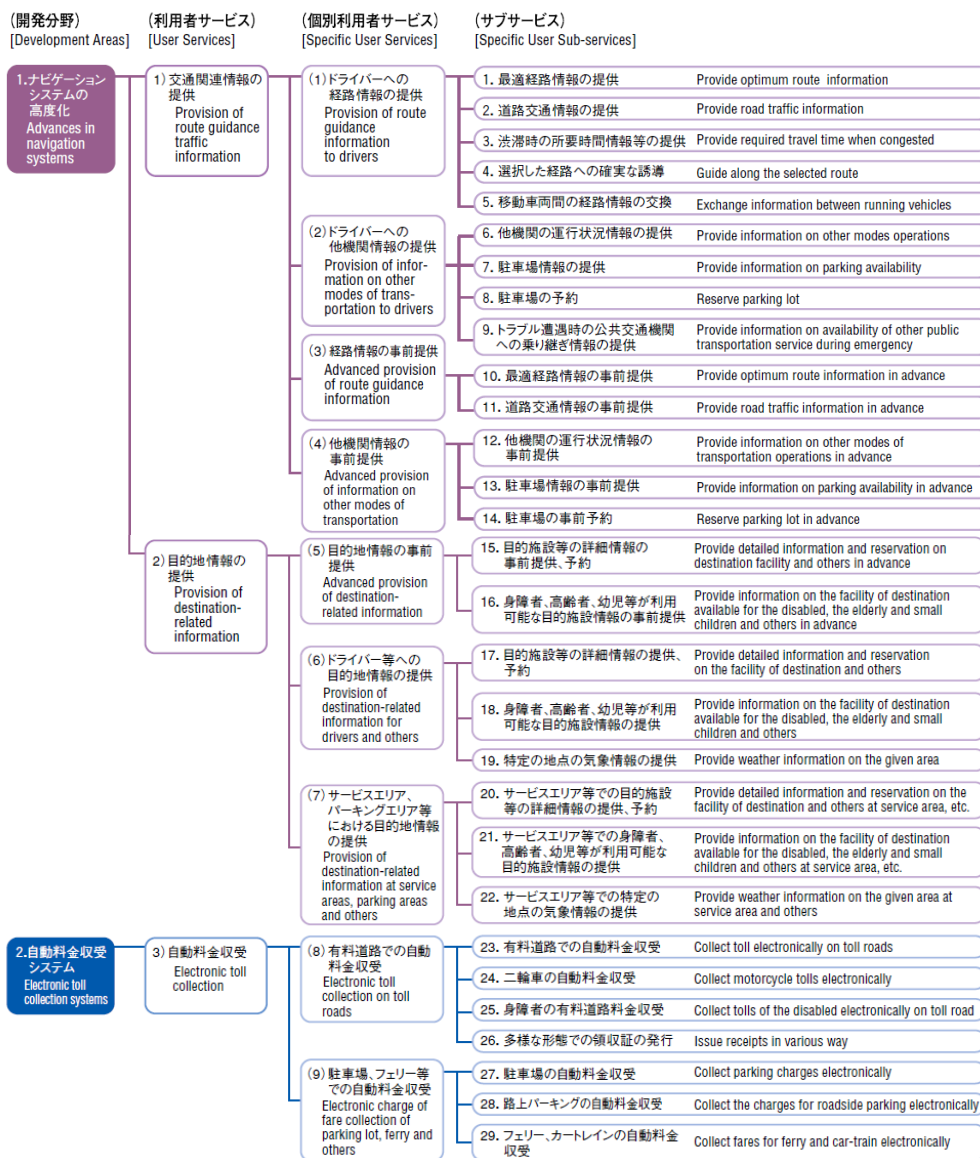

Figure 5.3-3 Legal systems on ITS

Source: Highway Industry Development Organization, ITS Handbook

(2) Development of Common Data Platform, such as Communication Standards

Many types of common data sets, such as traffic data and weather data, are utilized by a variety of ITS applications. As it is a waste of time and effort to collect common data sets individually for each application, it is recommended that such common data sets be shared and commonly used among the relevant applications.

To ensure the shared use of common data, we consider it effective to establish communication standards, which commonly define the methods of data exchange and the data to be exchanged.

It is also important to establish and maintain common data platforms and the relevant governmental agencies should take the lead in collecting and maintaining a variety of traffic statistical data, GIS map data and other relevant data, which form the basis for transportation planning.

[Reference] Road Communications Standards in Japan

In Japan, the Road Communication Standard has been established to serve as a common data platform. As the methods of communications between the centre and road managers, roadside units, onboard unit, etc., are unified under the Road Communication Standard, it is possible to facilitate the sharing of information and coordination among the related organisations and facilitate the procurement of devices.

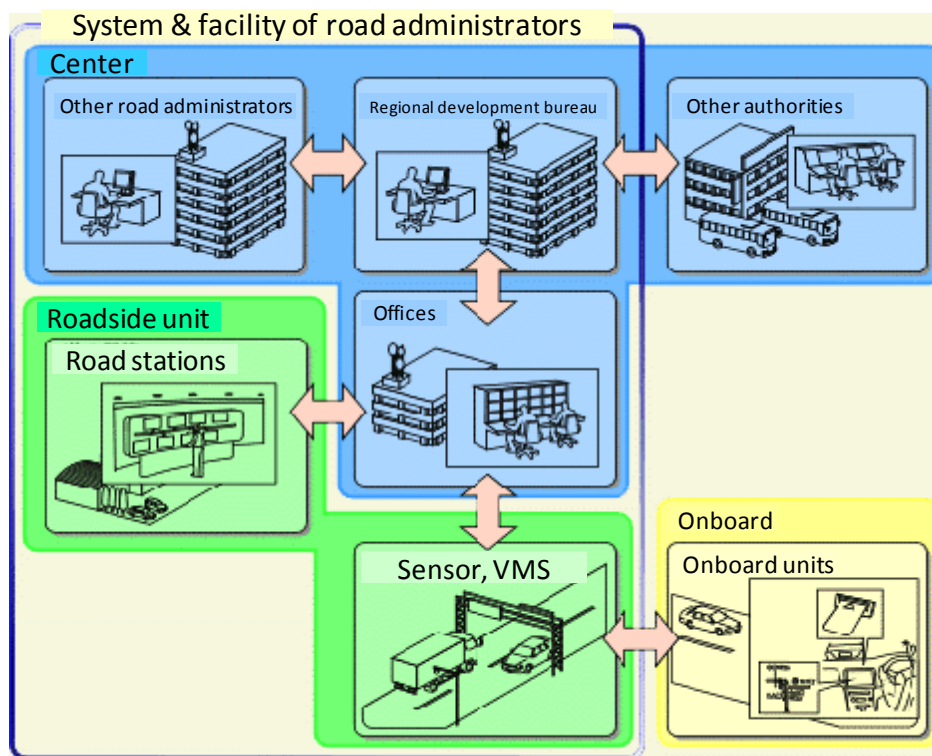

Figure 5.3-4 Target area of road communication standard

Source: National Institute for Land and Infrastructure Management, <http://www.rcs.nilim.go.jp/>

5.4 Step-Up Approach to the Introduction of ITS

5.4.1 Concept of Step-Up Approach

When introducing ITS, it is effective to take a step-up approach; start introducing devices and applications which are in greater need and whose initial costs are lower and then extend them in stages, by foreseeing and envisioning the future of ITS in terms of scalability, interconnectivity and other relevant factors.

In countries where road construction and improvement projects are continuously in progress, such as less developed countries, it is effective to study the implementation of ITS and its applications in conjunction with such individual road construction and improvement projects. This could contribute to the earlier achievement of the benefits from the projects, while foreseeing and envisioning the future nationwide deployment of ITS and the future scalability of ITS applications.

In the early stages of the introduction of ITS, it is effective to take the following actions in parallel; identify issues relating to road traffic characteristics of target areas for ITS introduction, find ITS promotion organisation and standardise ITS systems.

5.4.2 Example of Model Deployment Plan

Some examples of the step-up approach are shown below.

By ensuring a common understanding of the overall ITS system architecture in the initial stages, it is expected that ITS can be deployed more efficiently and effectively without wasting time and effort and without redoing the same process.

■ Example of Expansion of ITS Applications using Transportation-related IC Cards

- In the initial stage, IC cards are introduced to support public transportation applications and EFC is introduced to allow a “touch and go” passage at an EFC tollgate.
- ↓
- Shift to free-flow tolling solution using DSRC, etc.
- ↓
- Evolve to multi-application DSRC systems.

■ Example of Expansion of ITS Applications: Collection and Provision of Traffic Information Using Probe car data Systems

- (Offline) probe car data systems are introduced to identify traffic congestion areas and study the selection of target areas for the introduction of probe car data systems. A digital road map (DRM) utilizing trajectory data is prepared.
- ↓
- Online probe car data systems are introduced to collect real-time traffic information.
- Traffic information is further refined by using probe car data systems in conjunction with roadside

units (cameras and traffic counters).

- Applications are further upgraded (provision of disaster information, regional information, etc.)

[Reference] Conceptual Flow of Step-Up Approach-Based Review

Image of ITS deployment

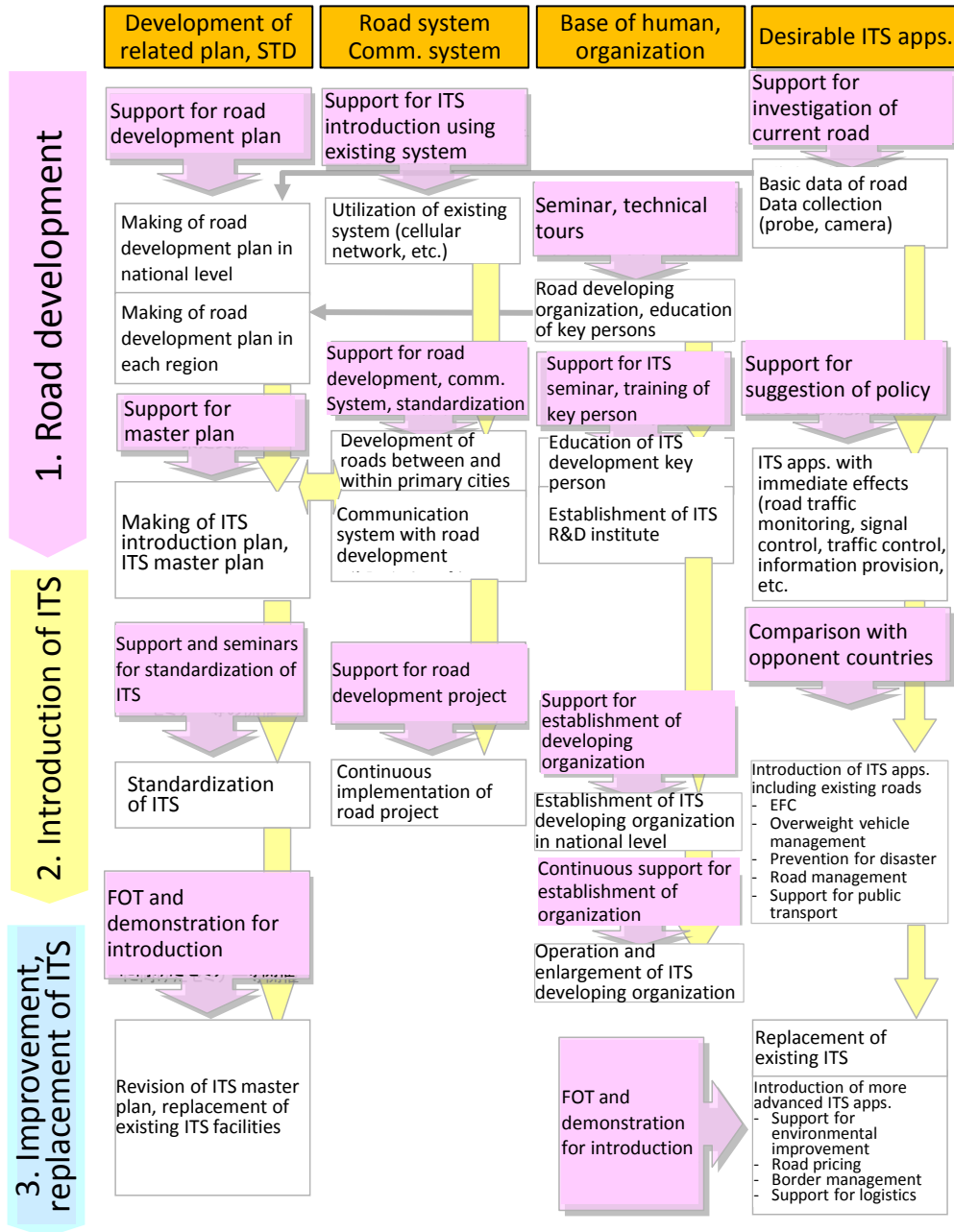

Figure 5.4-1 Conceptual flow of ITS deployment

5.5 Training and Education

5.5.1 Need and Necessity of Training and Education

In order to operate and deploy ITS on a sustainable basis, it is essential to continually train and educate the expert engineers who are thoroughly versed in ITS.

Expertise and knowledge about ITS that needs to be acquired include the ability to identify issues in target areas and routes and propose solutions using ITS; component technologies necessary for the development of ITS systems (such as communication technologies); the ability to develop organisations and systems to support the introduction of ITS; and the ability to operate and evaluate ITS systems.

5.5.2 Useful Tools for ITS Training and Education

It is helpful to effectively utilize websites and other available materials concerning ITS when implementing ITS training and education. Some of the available guidebooks and websites that are useful for ITS training and education are shown below. In order to ensure the successful introduction of ITS, it is also useful to review the examples of ITS introduction in other countries where the effectiveness of ITS has already been measured.

■ Examples of Useful Guidebooks and Websites for ITS Training and Education

- ITS Technical Notes (World Bank)

<http://go.worldbank.org/0TF9LEGIL0>

- Road Network Operations & Intelligent Transport Systems Manual (PIARC)

<http://www.piarc.org/en/knowledge-base/road-network-operations/Road-Network-Operations-Intelligent-Transport-Systems-Manual/>

- ITS-JAPAN

<http://www.its-jp.org/>

- Road Bureau, Ministry of Land, Infrastructure, Transport and Tourism, JAPAN

http://www.mlit.go.jp/road/road_e/index_e.html

- ITS Division, National Institute for Land and Infrastructure Management, MLIT, JAPAN

<http://www.nilim.go.jp/lab/qcg/eindex.htm>

- Japan International Cooperation Agency (JICA)

<http://www.jica.go.jp/english/index.html>

- Japan Society of Civil Engineers (JSCE)

<http://www.jsce.or.jp/>

- Asian Civil Engineering Coordinating Council(ACECC)

<http://www.acecc-world.org/>

- International Association of Traffic and Safety Sciences(IATSS)

<http://www.iatss.or.jp/en/>

Reference

- [1] United Nations, Department of Economic and Social Affairs, Population Division (2014). World Urbanization Prospects: The 2014 Revision, Highlights (ST/ESA/SER.A/352).
- [2] OECD/ITF (2015), ITF Transport Outlook 2015, OECD Publishing/ITF.
<http://dx.doi.org/10.1787/9789282107782-en>
- [3] IEA (2013), CO2 Emissions from Fuel Combustion 2013, IEA, Paris. DOI:
http://dx.doi.org/10.1787/co2_fuel-2013-en
- [4] World Health Organization (2008). The global burden of disease: 2004 update.
- [5] ITS Forum (2009). Experimental Guideline for Vehicle Communications System using 700 MHz-Band, <http://www.itsforum.gr.jp/Public/Eguideline/index.html>
- [6] Japan Society of Traffic Engineers (2006). Manual on Traffic Signal Control, Revised Edition [in Japanese]
- [7] HIDO (2015). ITS Handbook.
- [8] Ministry of Transportation and Communications of Taiwan (2004). The Master Plan of Intelligent Transport Systems in Taiwan. Executive Summary of the 2004 Edition.

6. Appendix: Acronyms

A	AHS	Advanced Cruise-Assist Highway Systems
	ANPR	Automatic number plate recognition
	ARIB	Association of Radio Industries and Businesses
	ASK	Amplitude Shift Keying
	ASL	Application Sub-Layer
	ATM	Active Traffic Management
B	BPSK	Binary Phase Shift Keying
C	CBD	Central Business District
	CCTV	Closed-Circuit Television
	C-ITS	Cooperative ITS
D	DQPSK	Differential Quadrature Phase Shift Keying
	DRB	Digital Radio Broadcasting
	DRG	Dynamic Route Guidance
	DRM	Digital Road Map
	DSRC	Dedicated Short Range Communications
E	EFC	Electronic Fee Collection
	EPS	Electronic Parking System
	ERP	Electronic Road Pricing
	ETC	Electronic Toll Collection
	EV	Electric Vehicle
G	GNP	Gross National Product
	GNSS	Global Navigation Satellite System
	GPS	Global Positioning System
H	HMI	Human Machine Interface
I	IC	Interchange
	IEA	International Energy Agency
	ISM	Industry science medical
	ITF	International Transport Forum
	ITS	Intelligent Transport Systems
	IVI	In vehicle Information

J	JBIC	Japan Bank for International Cooperation
	JICA	Japan International Cooperation Agency
L	LOS	Line of Sight
M	MLIT	Road Bureau of Ministry of Land, Infrastructure, Transport, and Tourism
	MRF	Markov Random Field
	MODERATO	Management by Origin-Destination Related Adaptation for Traffic Optimization
	MOVA	Microprocessor Optimized Vehicle Actuation
N	NILIM	National Institute for Land and Infrastructure Management
O	OBU	On Board Unit
	ODA	Official Development Assistance
	OECD	Organization for Economic Cooperation and Development
	OPAC	Optimized Policies for Adaptive Control
P	PFI	Private Finance Initiative
	PPP	Public Private Partnership
	PRODYN	Programming Dynamic
	PTPS	Public Transport Priority System
Q	QPSK	Quadrature Phase Shift Keying
	QZSS	Quasi-Zenith Satellite System
R	RFID	Radio Frequency Identification
	RSU	Road Side Unit
S	SCATS	Sydney Coordinated Adaptive Traffic Systems
	SCOOT	Split Cycle Offset Optimization Technique
U	UTOPIA	Urban Traffic Optimization by Integrated Automation
V	VICS	Vehicle Information and Communication System
	VMS	Variable Message Signboard
	V2I	Vehicle to Infrastructure
	V2V	Vehicle to Vehicle

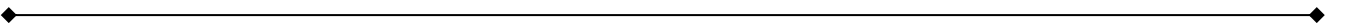

Intelligent Transport Systems (ITS)

Introduction Guide

Version 1.1

August 2016

Japan Society of Civil Engineers

(JSCE)

The Asian Civil Engineering Coordinating Council

(ACECC)

